



GSM/GPS/UMTS/WiFi ANTENNA

Antenna GSM/UMTS/GPS/WiFi
Screw Mount R41, RG174/1.5m,
2x SMA(m), SMA-RP(f)

AO-AKOM-41SSSRP15

SECTRON company offers a wide portfolio of GSM/GPS/UMTS/Wi-Fi antennas with various versions differing in shape, level of gain and manner of attachment. SECTRON guarantees a compatible connection between an antenna and all antenna adaptors produced by SECTRON.



BENEFITS

- Easy installation
- High frequency range
- High gain

FEATURES

AO-AKOM-41SSSRP15

Technology	GSM/GPS/UMTS/WIFI
Frequency bands	900/1575.42/1800/2100/2400 MHz
Bandwidth	-
Gain	0.2/32/8/6 dBi
LNA Gain	30 dBi
VSWR	<2.0:1
Impedance	50 Ohm
Directivity	Directional
Beam angle	Attached graphs below
Polarization	Linear
Maximum input power	10 W
Power voltage	-
Dimensions	Ø 80 x 25 mm
Weight	153.16 g
Operating temperature	-30 to +90 °C
Execution	External
Method of attachment	Screw Mount
Cable type	3 x RG174U
The cable length	3 x 1.5 m
Connector type	2 x SMA(m) – GSM/GPS, 1x SMA RP Wi-Fi
Certification	ISO 9001, ISO 14001

DRAWING

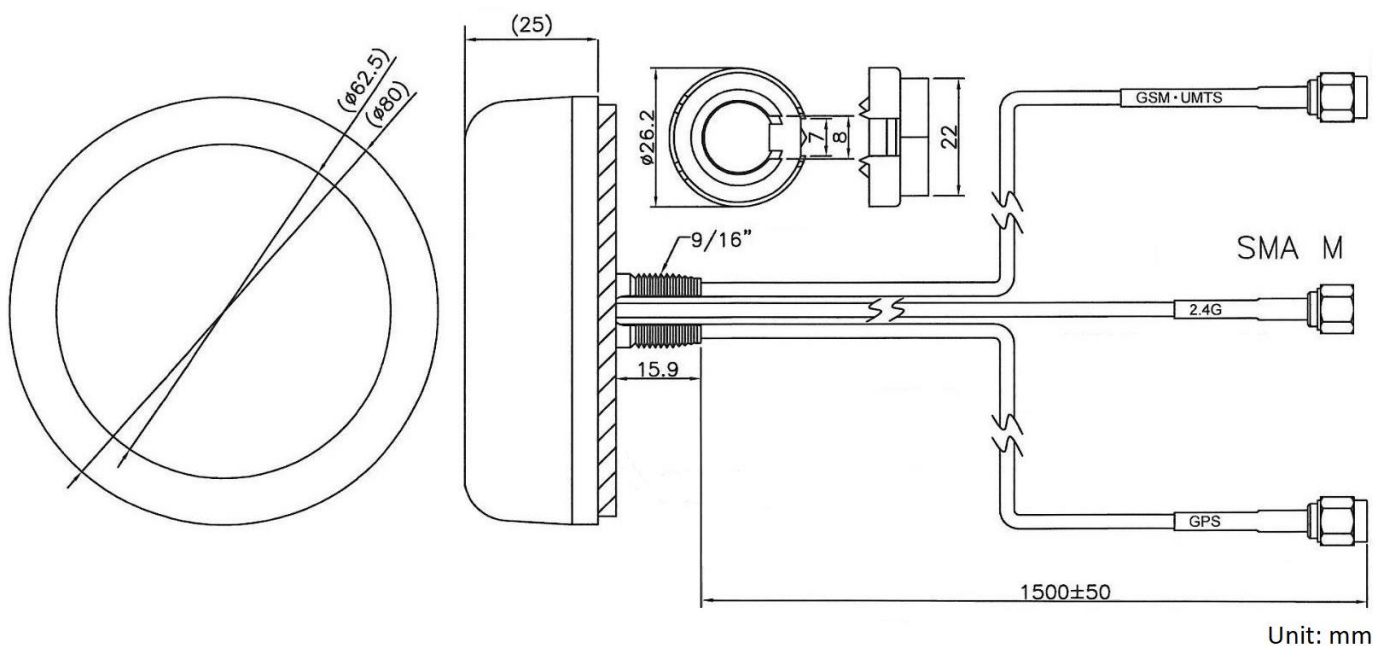

Frequency [MHz]	Return Loss [dB]	VSWR	Efficiency [%]	Gain [dBi]
1575.42 (GPS)	-17.59	1.3	-	32.27
900 (GSM)	-8.44	2.23	40.83	0.21
1800 (UMTS)	-12.48	1.61	79.62	8.52
2100 (UMTS)	-8.13	2.29	26.18	2.47
2400 (Wi-Fi)	-12.29	1.64	59.43	6.2
2450	-17.34	1.36	54.2	4.91
2500	-20.43	1.21	47.21	4.33

S11-GPS

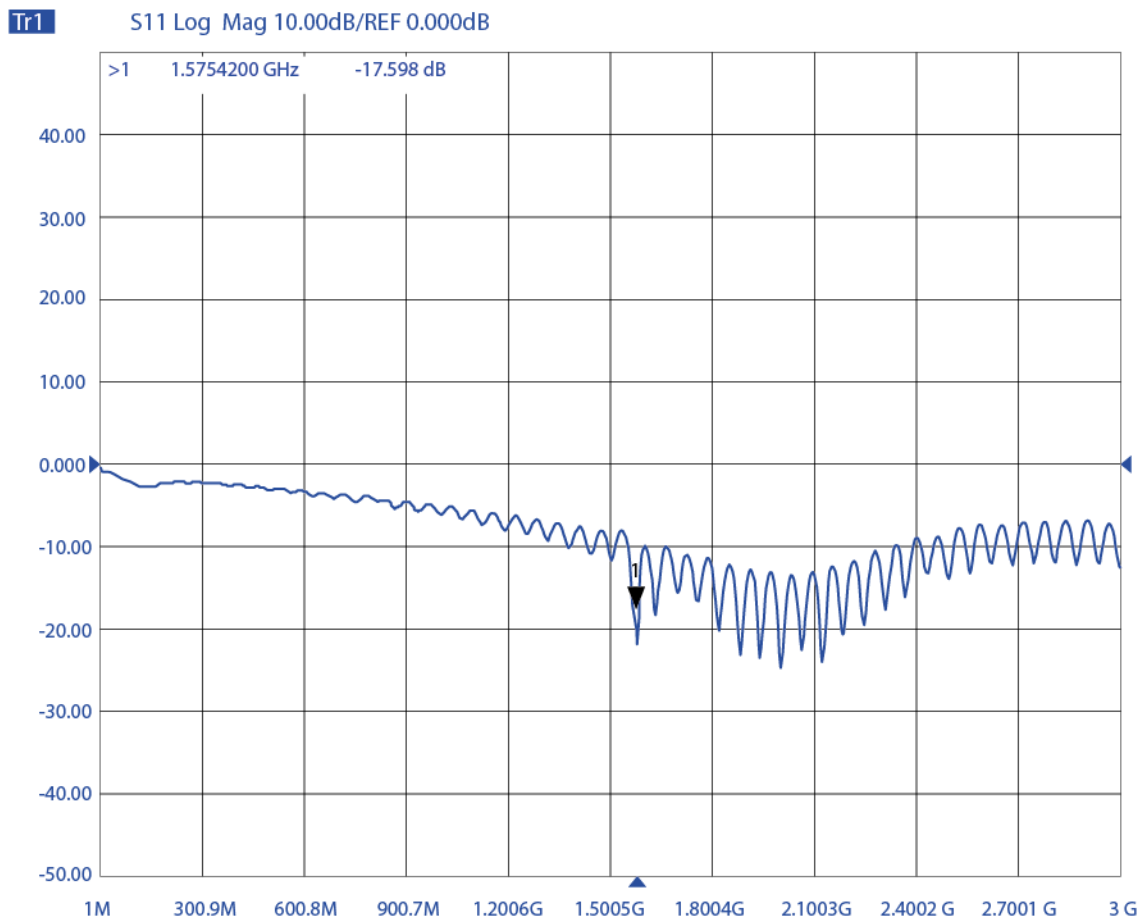

S11-GSM/UMTS

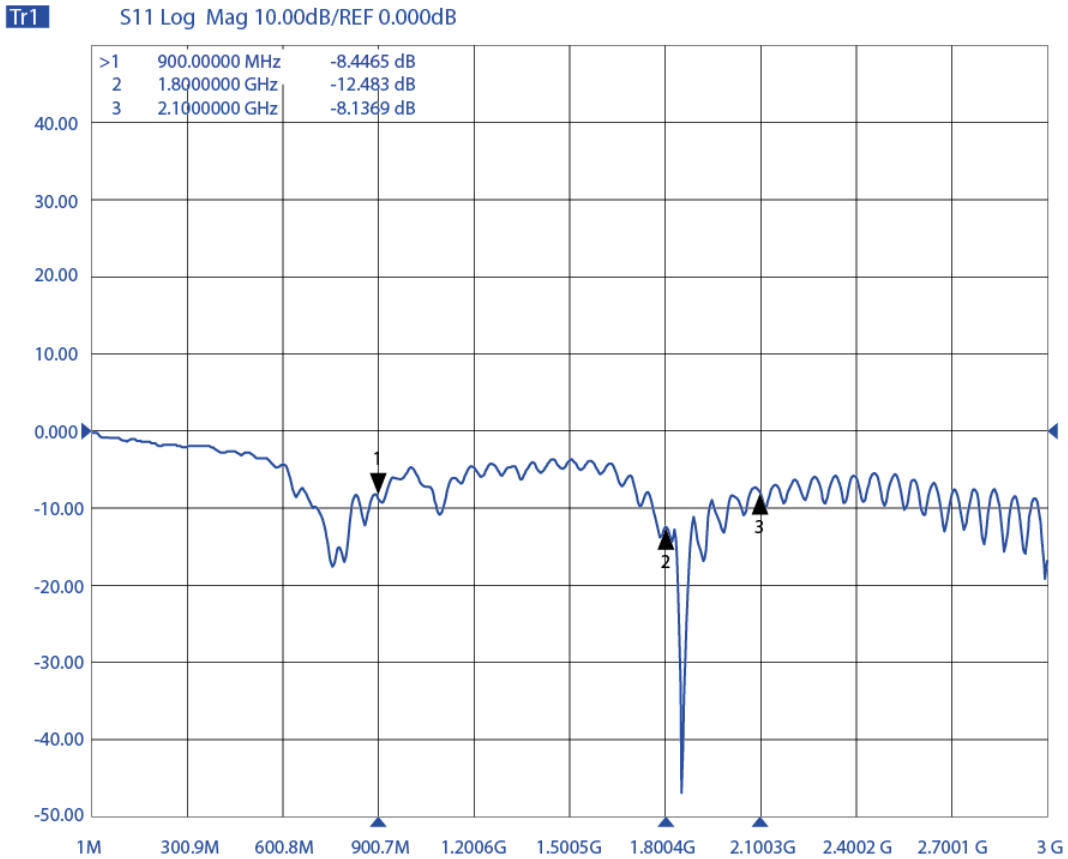

S11-Wi-Fi

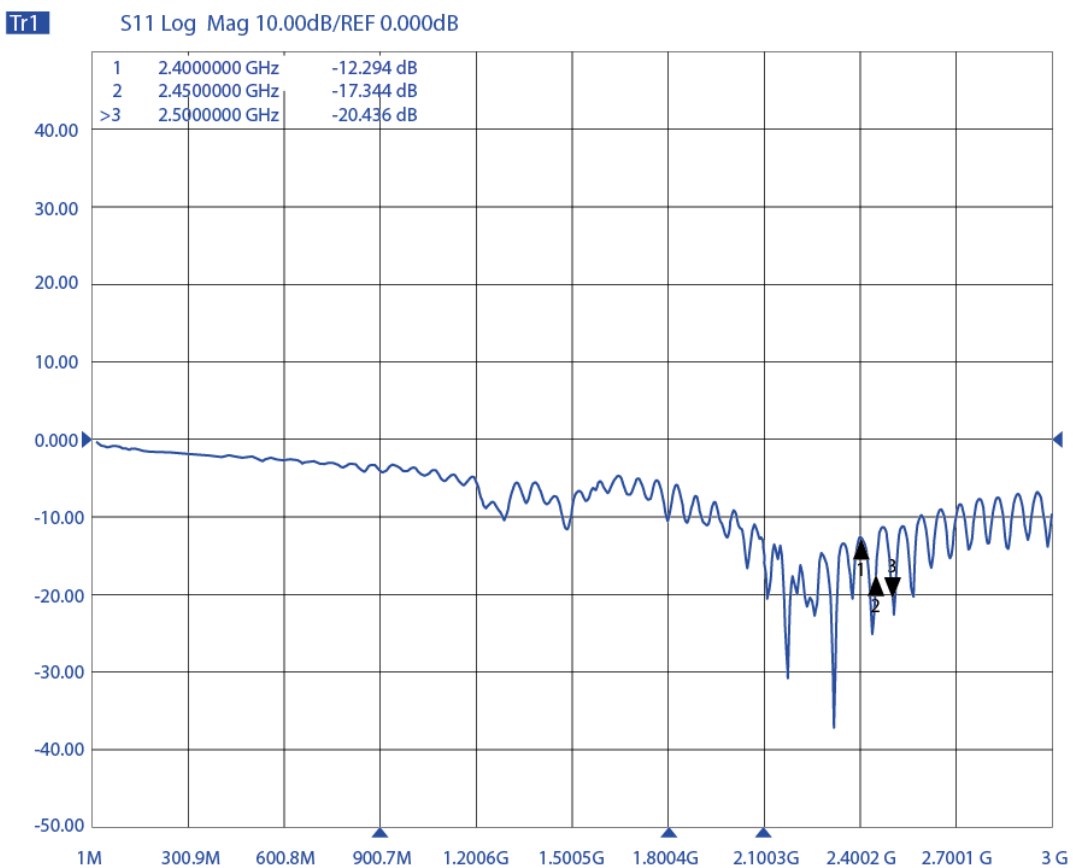

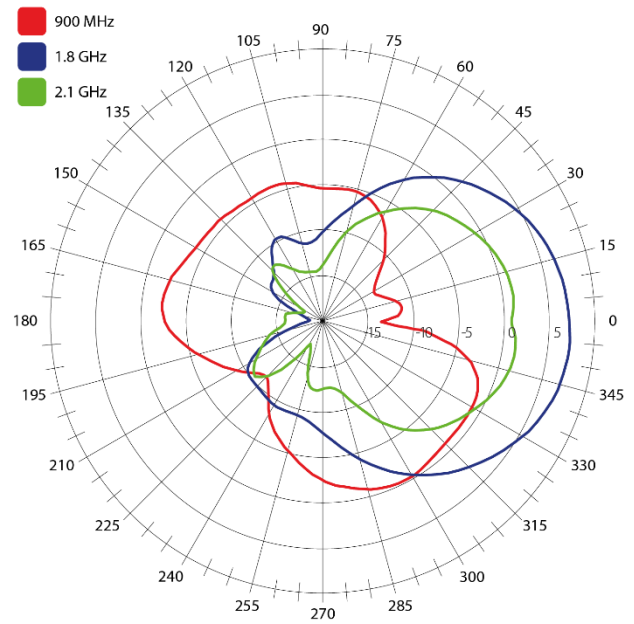
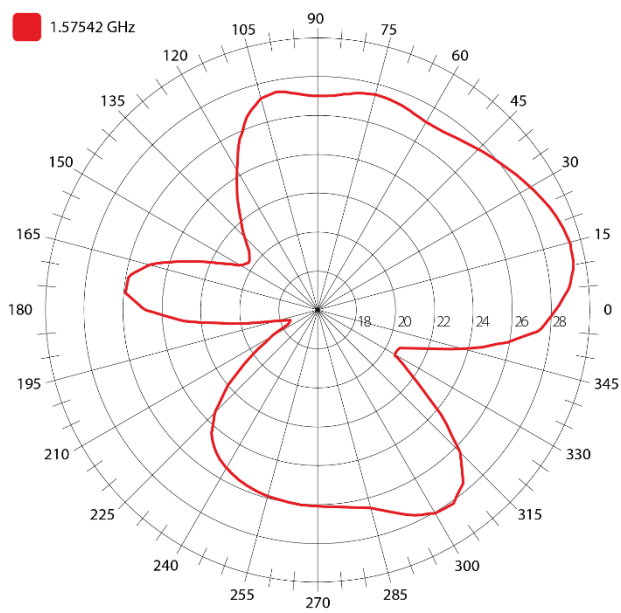

RADIATION PATTERN

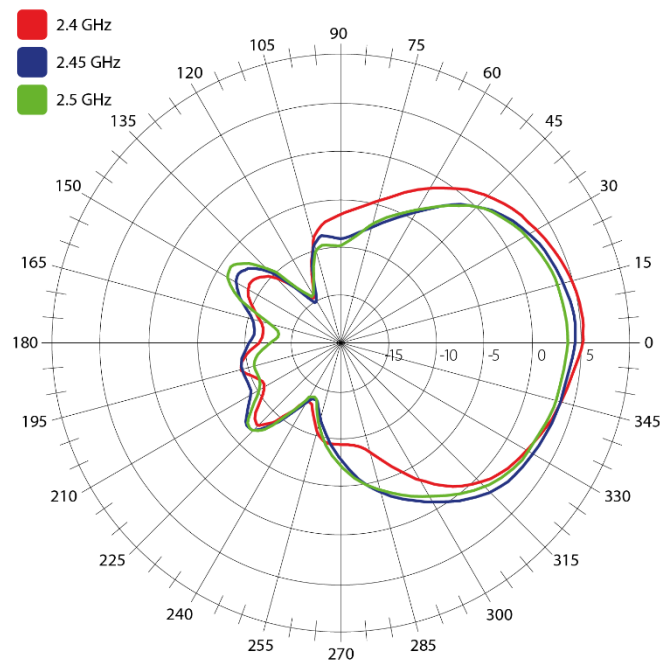

VARIANTS

Different connector variants or cable lengths are available on request.

CONTACTS

SECTRON s.r.o. Josefa Šavla 1271/12
709 00 Ostrava 9, Czech Republic

WWW.SECTRON.CZ
Tel.: +420 556 621 020