



GSM/UMTS/LTE ANTENNA

Antenna GSM/UMTS/LTE
Mounting, SMA(m), RG174/3m,
IP67

AO-ALTE-36S

SECTRON company offers a wide portfolio of GSM/UMTS/LTE antennas with various versions differing in shape, level of gain and manner of attachment. SECTRON guarantees a compatible connection between an antenna and all antenna adaptors produced by SECTRON.

BENEFITS

- Low VSWR
- Easy installation
- IP67
- Wide-band antenna



FEATURES

AO-ALTE-36S

Technology	GSM/UMTS/LTE
Frequency bands	800~900/1700~2100/2500~2700 MHz
Bandwidth	-
Gain	2 dBi
VSWR	<2.0:1
Impedance	50 Ohm
Directivity	Omnidirectional
Beam angle	Attached graphs bellow
Polarization	Linear
Maximum input power	10 W
Power voltage	-
Dimensions	Ø 54.4 x 43 mm
Weight	125 g
Operating temperature	-30 to +80 °C
Execution	External
Method of attachment	Screw mount
Cable type	RG174/U
The cable length	3 m
Connector type	SMA(m)
Certification	RoHS, ISO9001, ISO14001, CNS 12681
IP Code	IP67

DRAWING

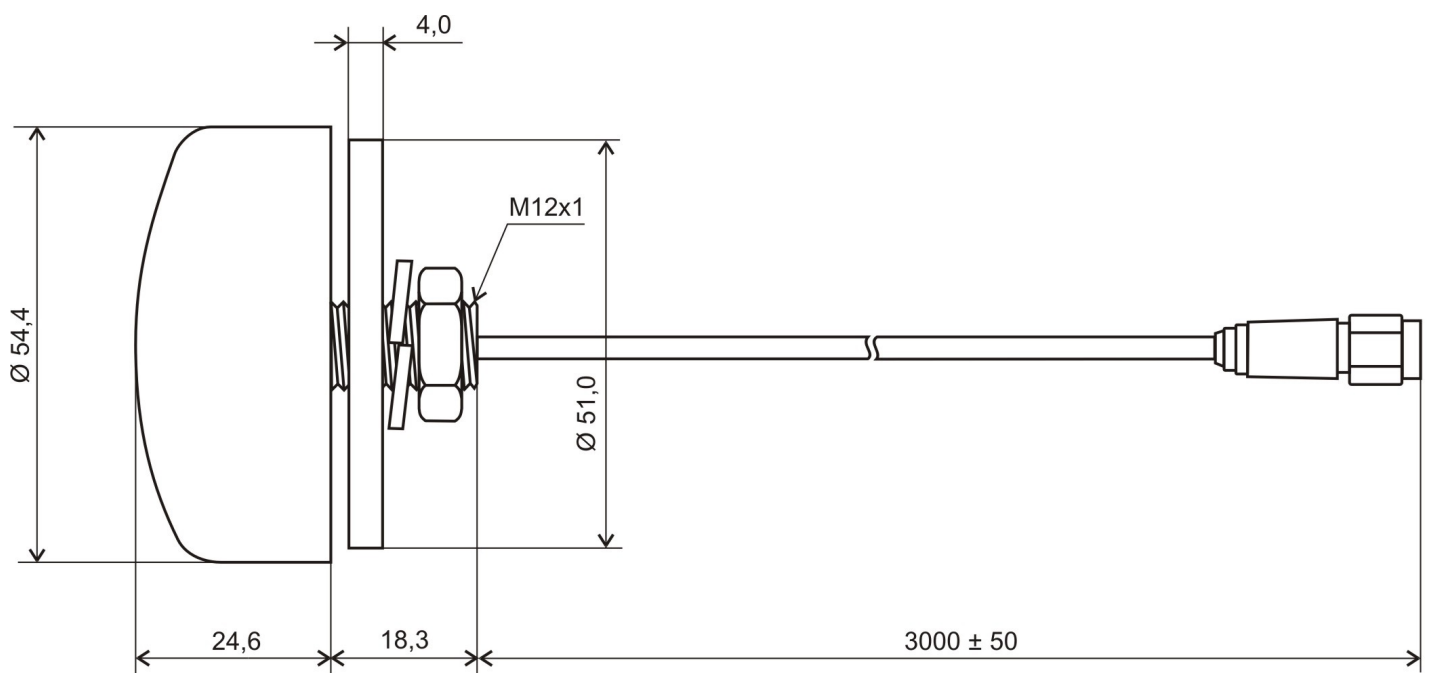

UNIT: mm

S_{11} - Return Loss [dB]

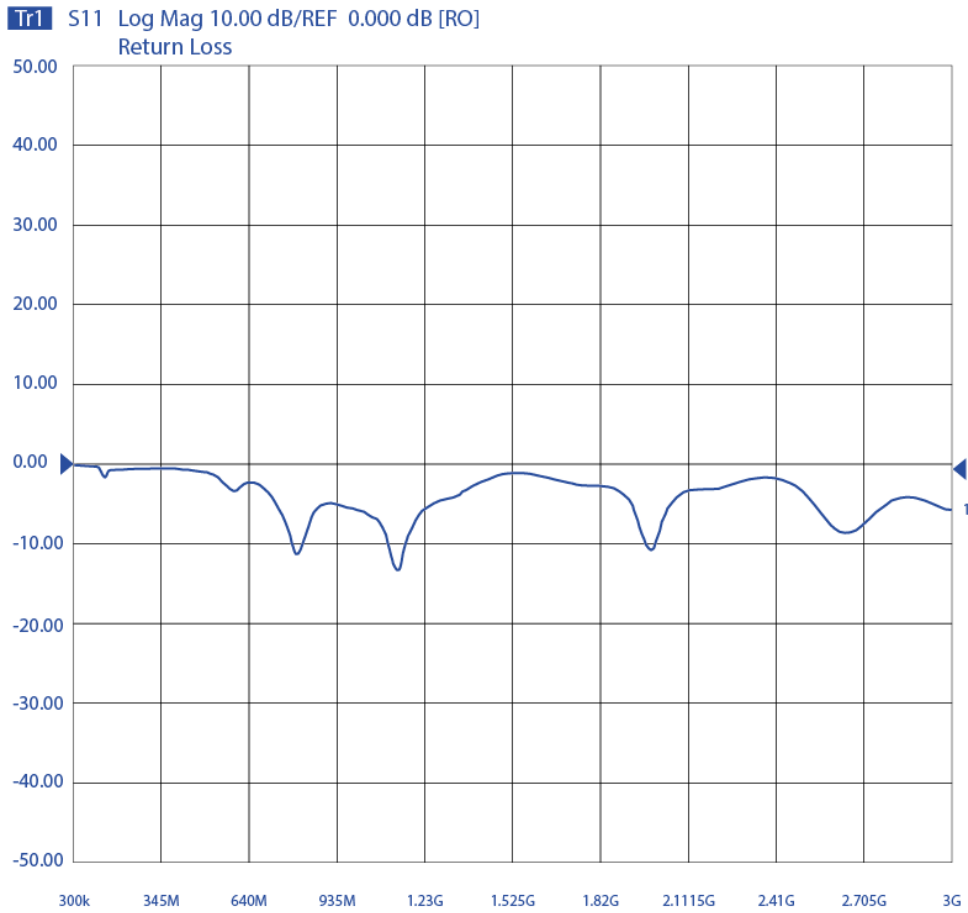

VSWR – Voltage standing wave ratio [-]

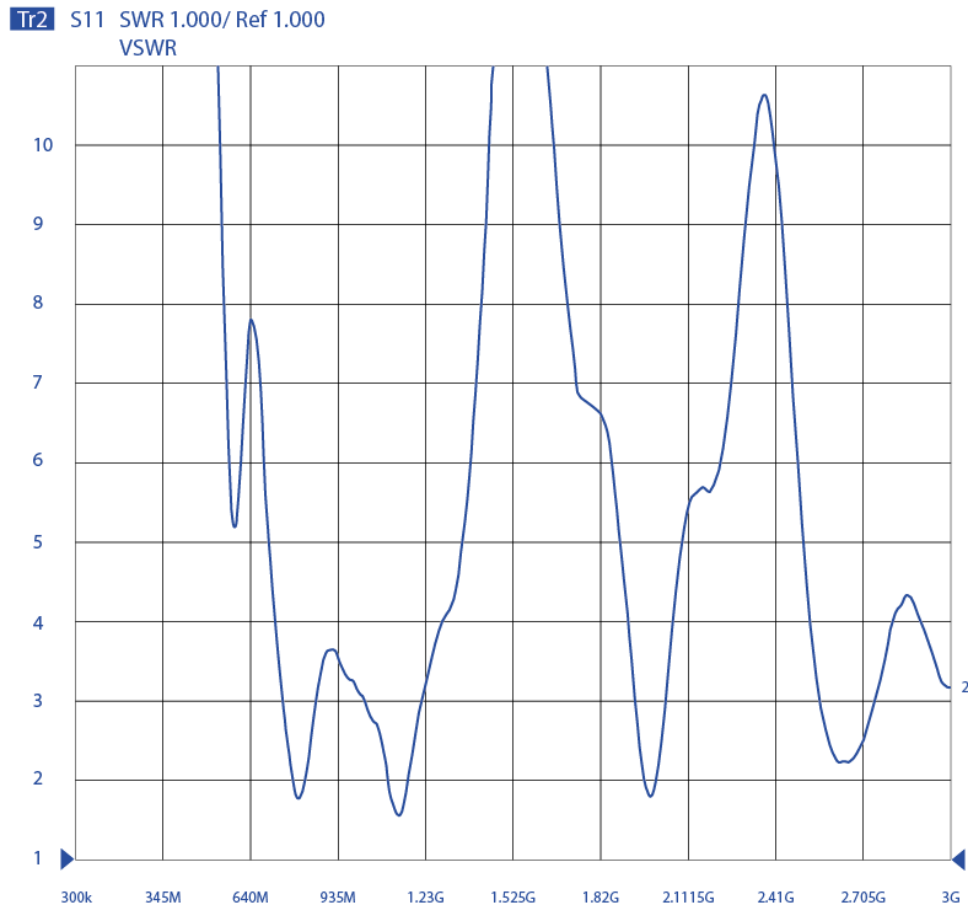

RADIATION PATTERN

800 MHz

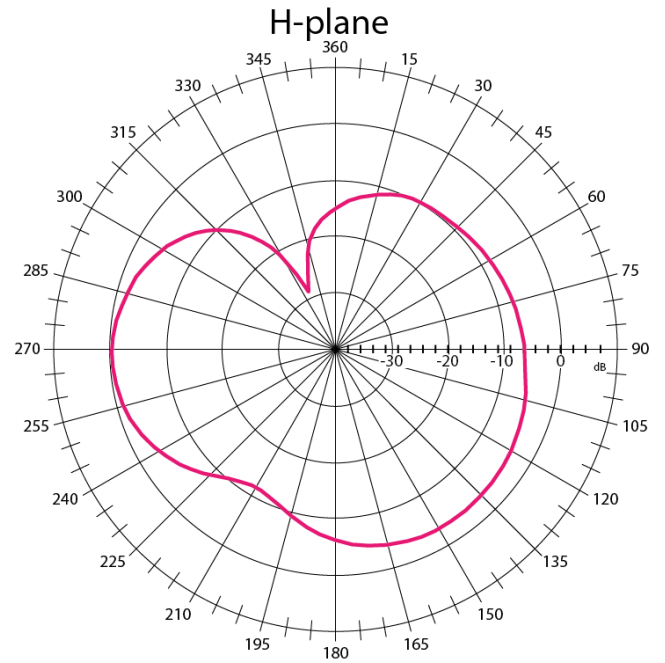
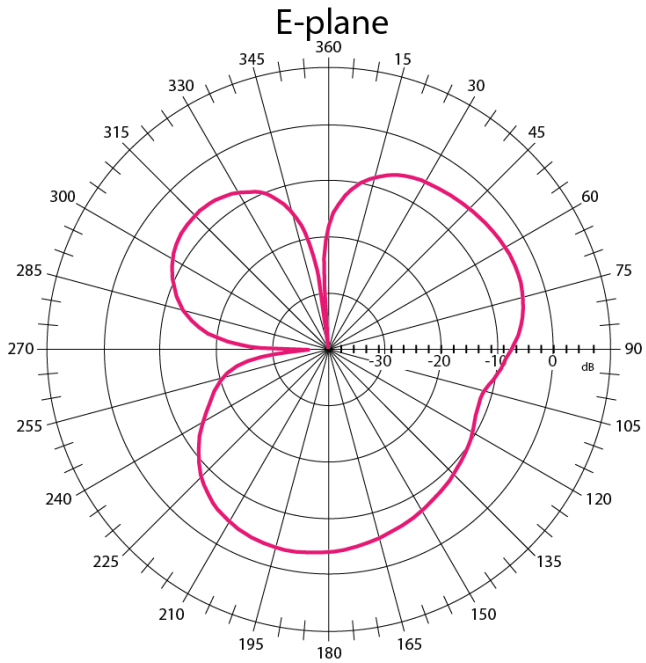

RADIATION PATTERN

1800 MHz

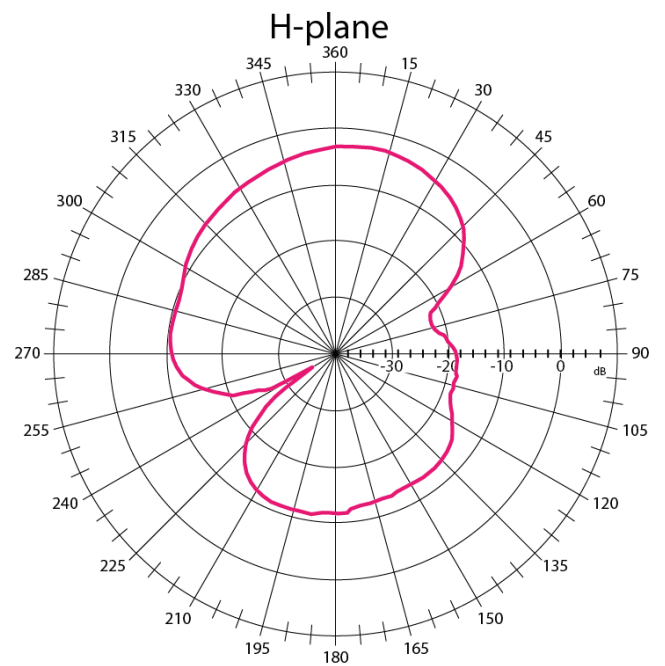
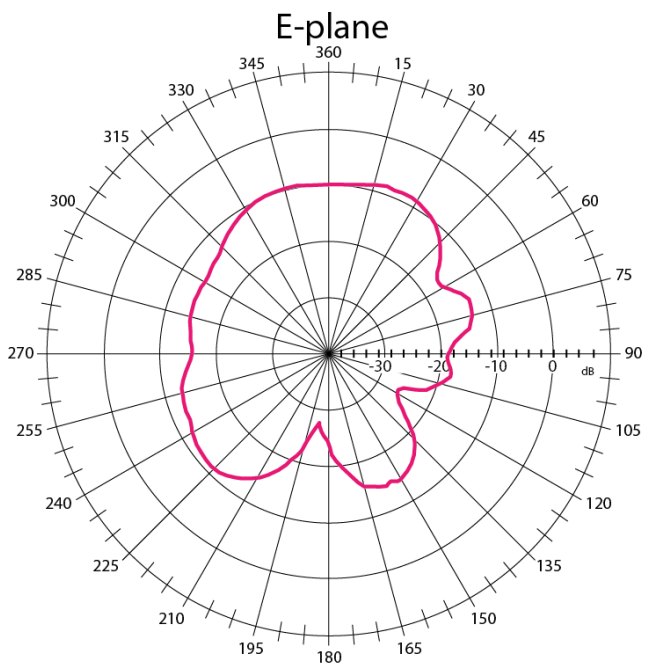

RADIATION PATTERN

2100 MHz

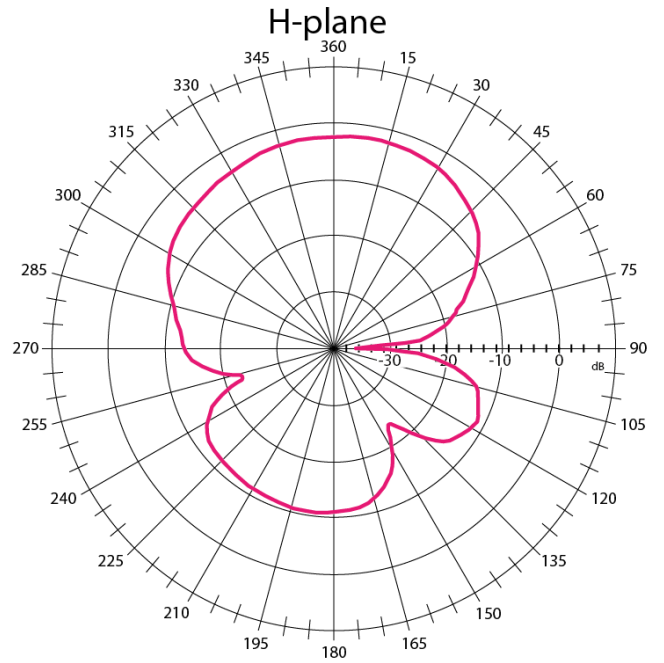
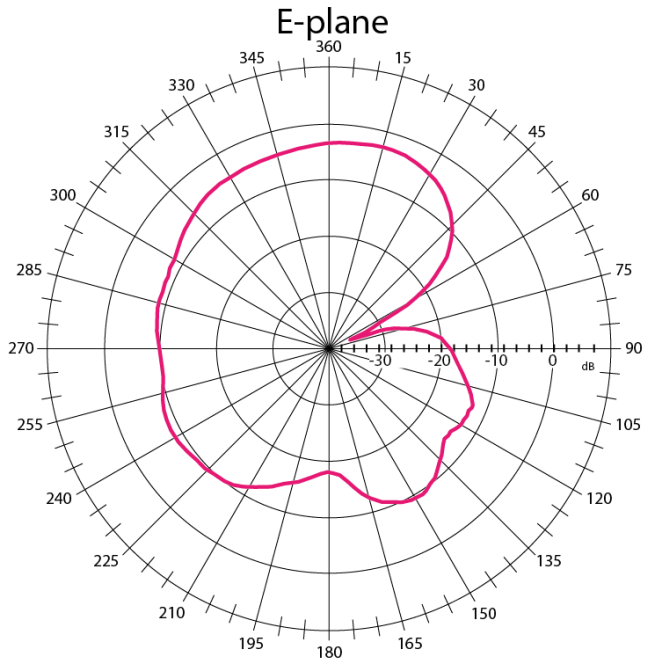

RADIATION PATTERN

2600 MHz

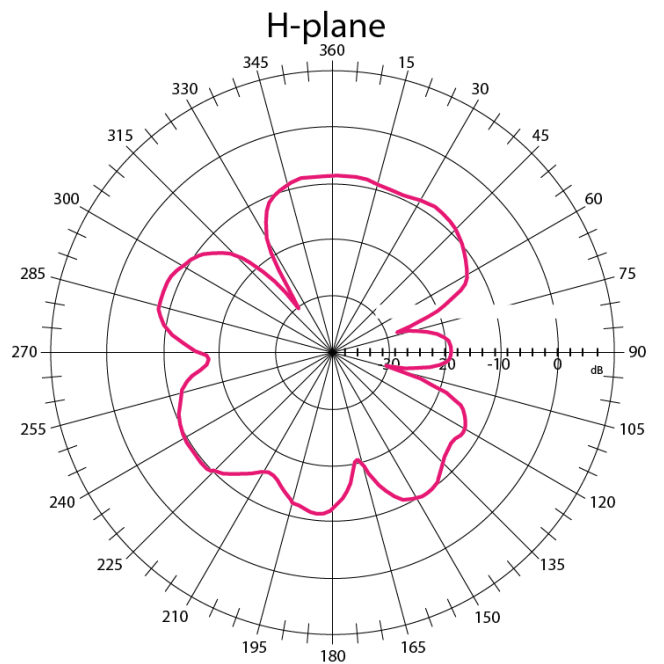
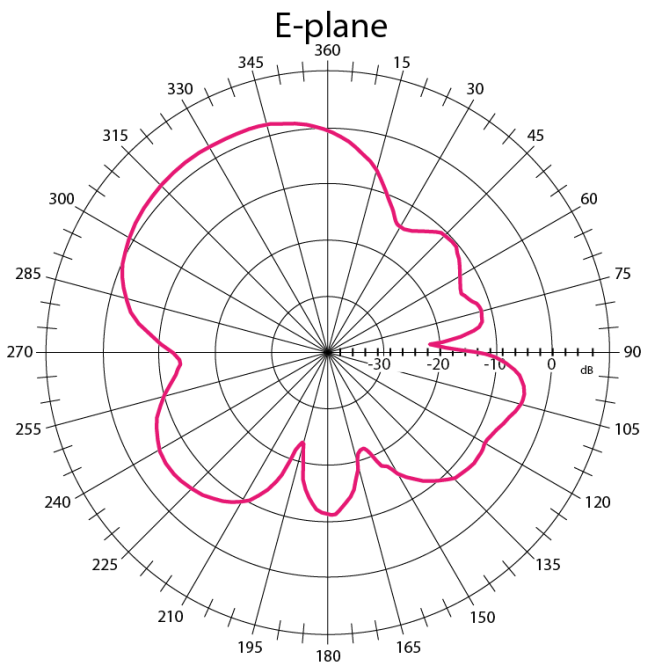

Frequency [MHz]	S_{11} [dB]	VSWR [-]
700	-8.40	2.22
880	-13.36	1.55
960	-14.34	1.47
1710	-10.57	1.84
1880	-15.07	1.42
2170	-10.57	1.84
2500	-10.69	1.82
2600	-14.14	1.49
2700	-14.83	1.44

VARIANTS

Different connector variants or cable lengths are available on request.

CONTACTS

SECTRON s.r.o. Josefa Šavla 1271/12
709 00 Ostrava 9, Czech Republic

WWW.SECTRON.CZ
Tel.: +420 556 621 020