



## CDMA ANTENNA

Antenna SET CDMA 450 MHz, Stick,  
Magnetic Base, Cable FME-SMA,  
RG174, 3m

AO-ACDMA-MG45

SECTRON company offers a wide portfolio of CDMA antennas with various versions differing in shape, level of gain and manner of attachment. SECTRON guarantees a compatible connection between an antenna and all antenna adaptors produced by SECTRON.



### BENEFITS

- Verified by the Austrian market
- Three-piece design for easy installation
- Adapted on 450 MHz frequency
- Low VSWR

Technology	CDMA
Frequency bands	450 MHz
Bandwidth	-
Gain	1.28 dBi
VSWR	< 1.6:1
Impedance	50 Ohm
Directivity	Omnidirectional
Beam angle	H 360° V 30°
Polarization	Linear
Maximum input power	10W
Power voltage	-
Dimensions	147 x $\varnothing$ 81 mm
Weight	223.1 g
Operating temperature	-40 to +85 °C
Execution	External
Method of attachment	Magnet Mount
Cable type	RG174/U
The cable length	3 m
Cable connector type	FME(F)
Base connector type	SMA(m), SMA(f)

DRAWING

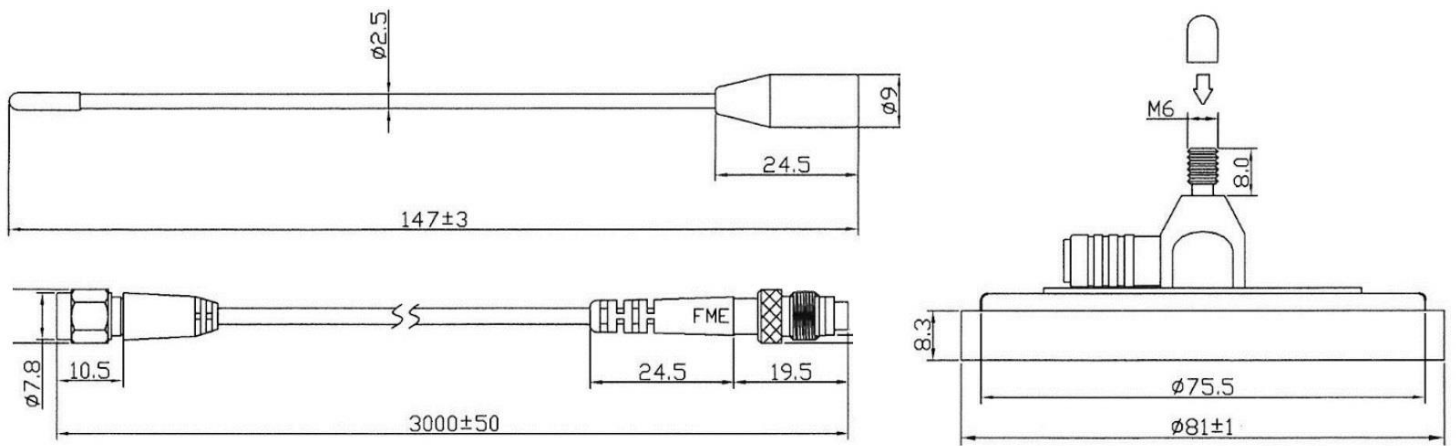

Unit: mm

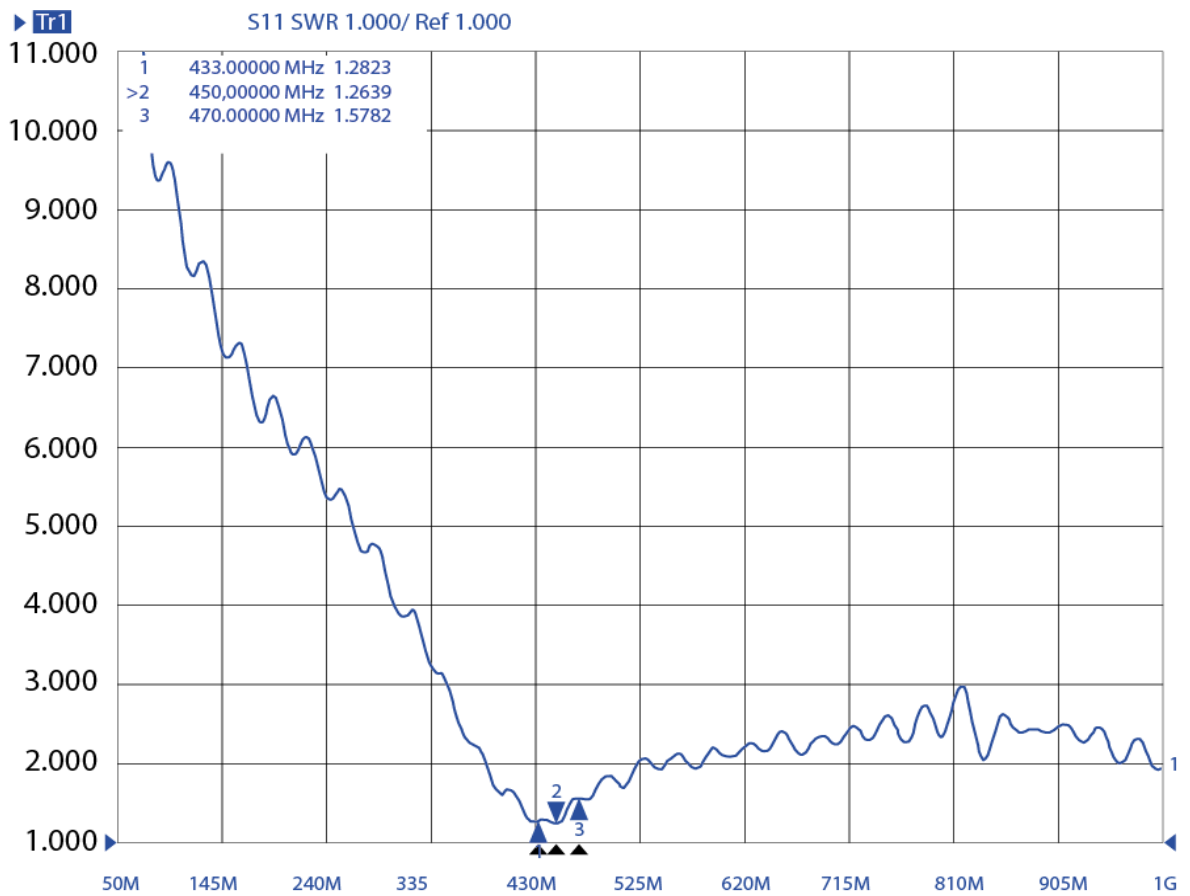
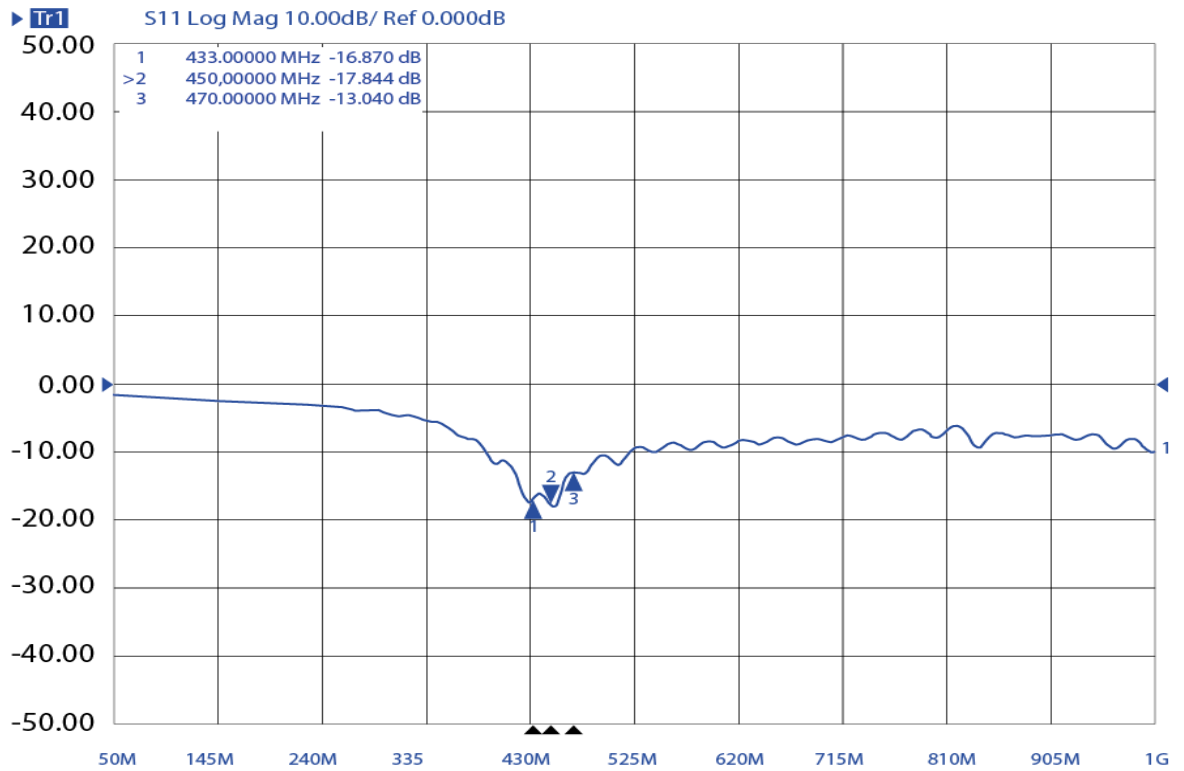

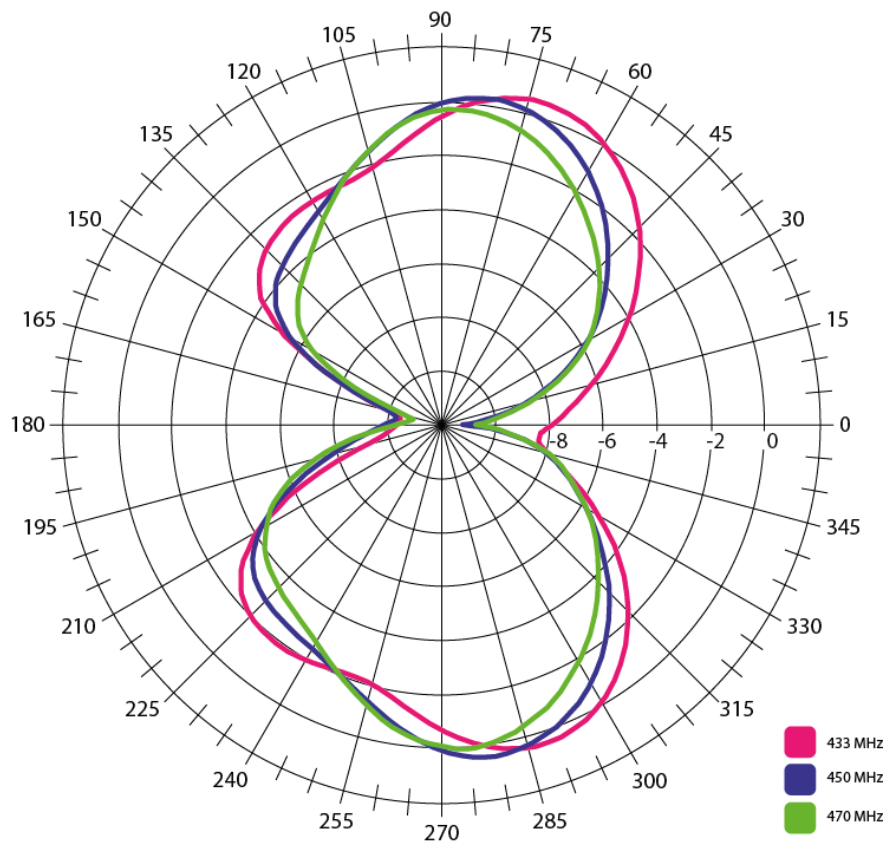

Total\_Efficiency (%)

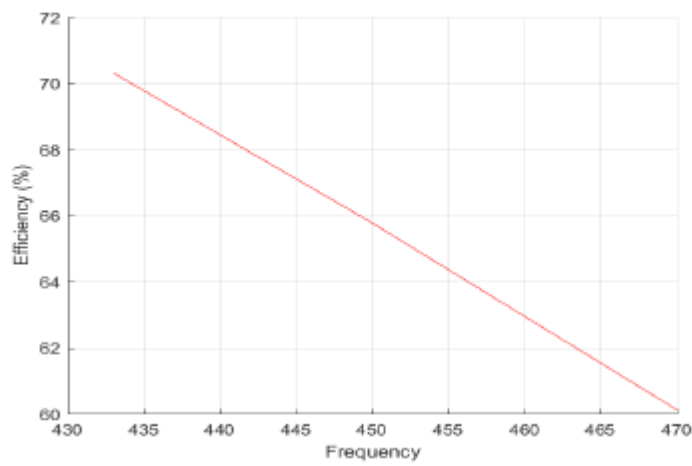

Total\_Gain (dBi)

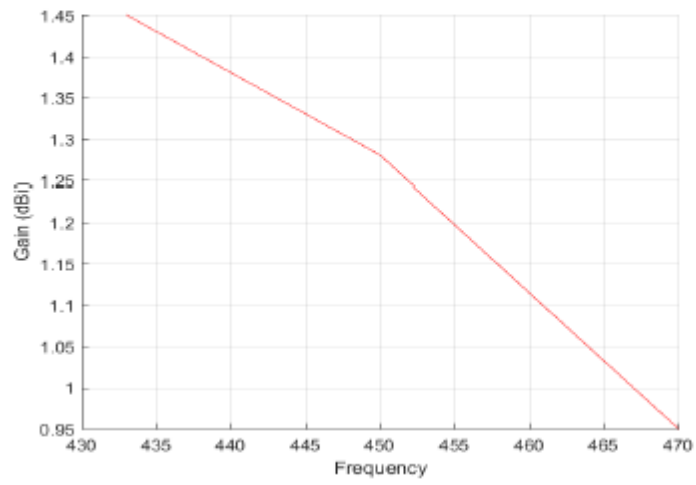

Total\_3D\_Side View 1\_430MHz

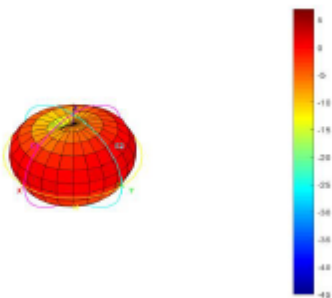

Total\_3D\_Side View 1\_450MHz

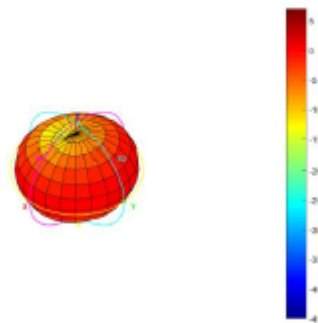

Total\_3D\_Side View 1\_470MHz

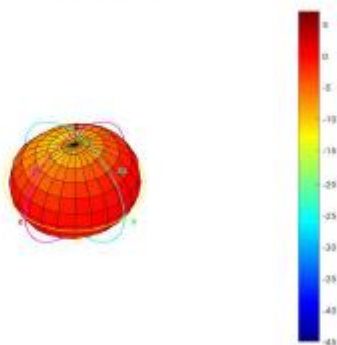

### ELECTRICAL

Frequency (MHz)	Return Loss (dB)	VSWR	Efficiency (%)	GAIN (dB)
433	-16.87	1.28	70.31	1.45
450	-7.84	1.26	65.77	1.28
470	-13.04	1.57	60.12	0.95

ALL VARIANTS

AO-ACDMA-MG45

Different connector variants or cable lengths are available on request.

CONTACTS

SECTRON s.r.o. Josefa Šavla 1271/12  
709 00 Ostrava 9, Czech Republic

WWW.SECTRON.CZ  
Tel.: +420 556 621 020