



LTE/GNSS ANTENNA

Anténa LTE/GNSS Magnetic 305L,
2xFAKRA, RG174/3m

AO-AKOM-B305LFF

SECTRON company offers a wide portfolio of LTE/GNSS antennas with various versions differing in shape, level of gain and manner of attachment. SECTRON guarantees a compatible connection between an antenna and all antenna adaptors produced by SECTRON.



BENEFITS

- Low VSWR
- High power supply range
- Easy installation

Technology	LTE/GNSS
Frequency bands	900/1800/1900/2100/1575.42 MHz
Bandwidth	5 MHz
Gain	0/28 dBi
VSWR	<2.0:1
Impedance	50 Ohm
Directivity	Omnidirectional
Beam angle	H 360° V 30°
Polarization	Linear/R.H.C.P.
Maximum input power	10 W
Power voltage	2.2 – 5 V DC
Dimensions	Ø 81.6 x 14.5 mm
Weight	148.28 g
Operating temperature	-30 to +90 °C
Execution	External
Method of attachment	Magnetic
Cable type	2 x RG174
The cable length	2 x 3 m
Connector type	2 x FAKRA

DRAWING

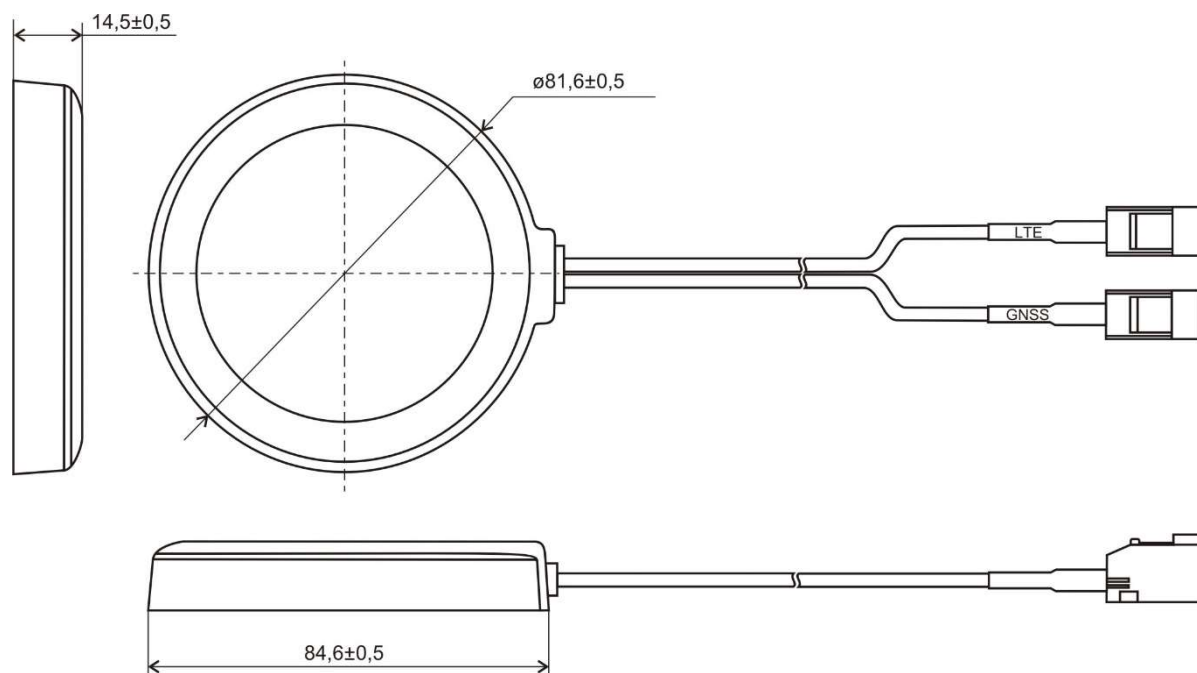

UNIT: mm

GPS Antenna

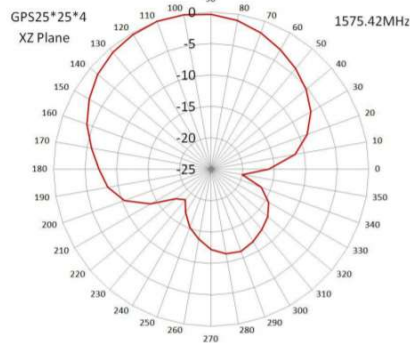
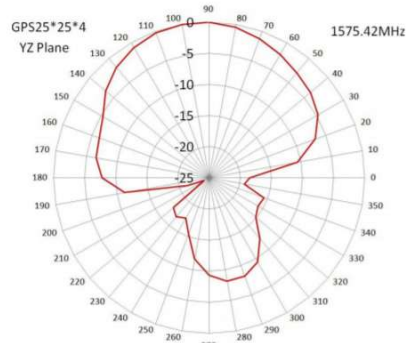
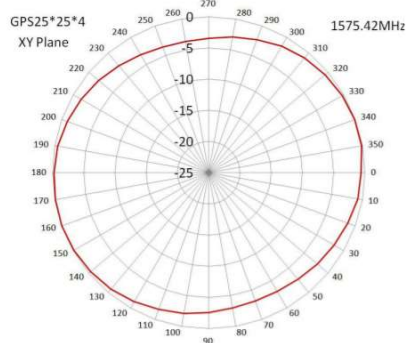

GSM Antenna

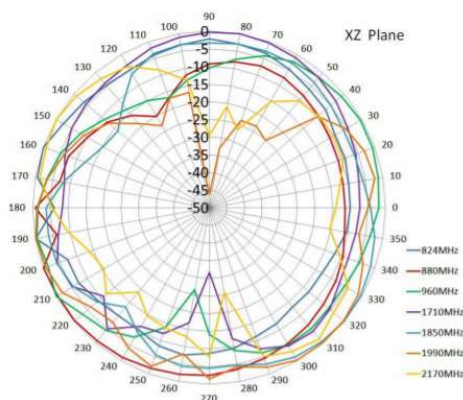
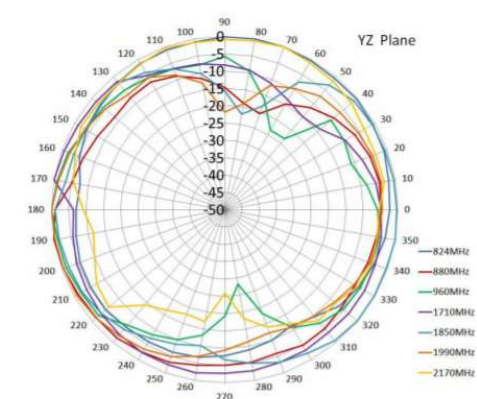
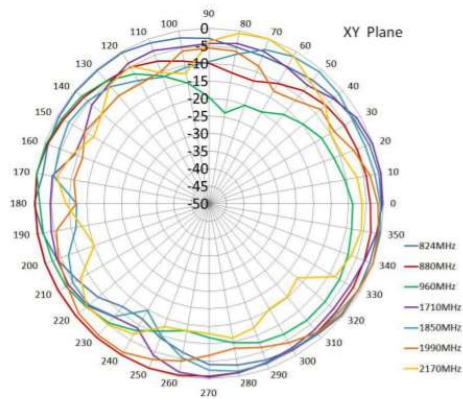

CONTACTS