



GSM/UMTS/LTE ANTENNA

Antenna GSM/UMTS/LTE Screw Mount PUK, SMA(m),
RG174/0.2m, IP67

AO-ALTE-36S020

SECTRON company offers a wide portfolio of GSM/UMTS/LTE antennas with various versions differing in shape, level of gain and manner of attachment. SECTRON guarantees a compatible connection between an antenna and all antenna adaptors produced by SECTRON.



BENEFITS

- Low VSWR
- High frequency range
- Easy installation

Technology	GSM/UMTS/LTE
Frequency bands	800/900/1700/1800/2100/2500/2600/2700 MHz
Bandwidth	-
Gain	0-2 dBi
VSWR	<2.0:1
Impedance	50 Ohm
Directivity	Omnidirectional
Beam angle	H 360° V 30°
Polarization	Linear
Maximum input power	10 W
Power voltage	-
Dimensions	Ø54.4 x 24.6 mm
Weight	55 g
Operating temperature	-30 to +80 °C
Execution	External
Method of attachment	Screw Mount
Cable type	RG174/U
The cable length	0.2 m
Connector type	SMA(m)
IP Code	IP67
Certification	ISO 9001: 2015 / CNS 12681

DRAWING

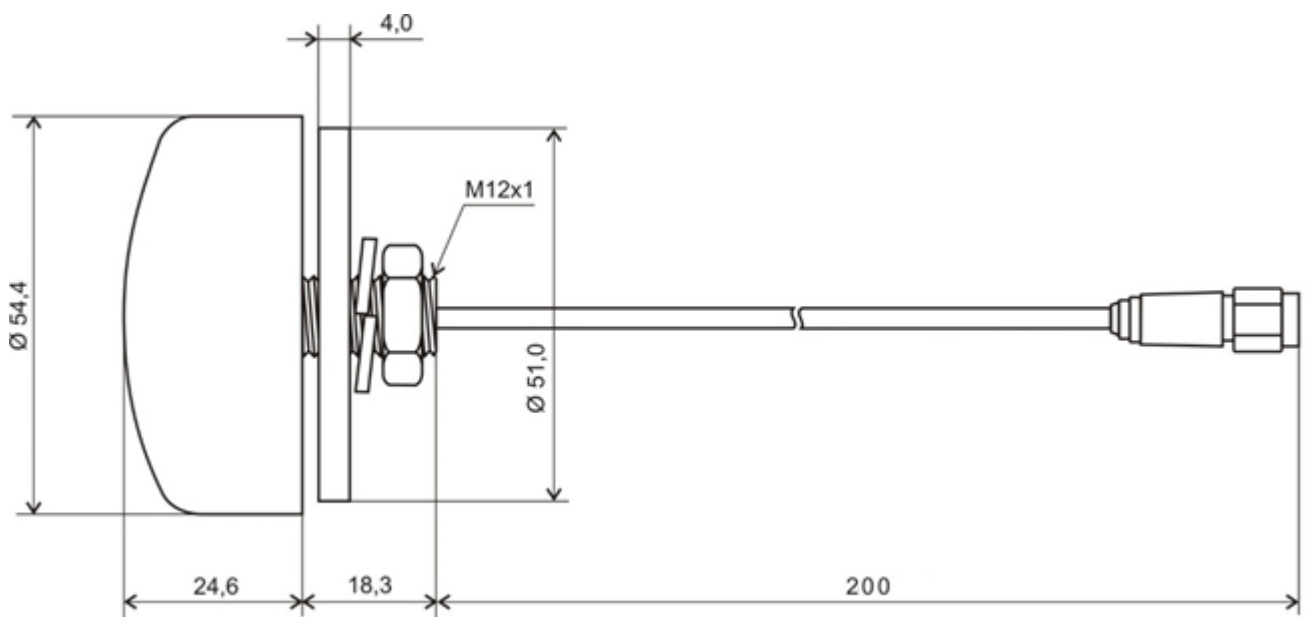

UNIT: mm

Graph VSWR – Standing wave ratio [-]

Tr2 S11 SWR 1.000/ Ref 1.000
VSWR

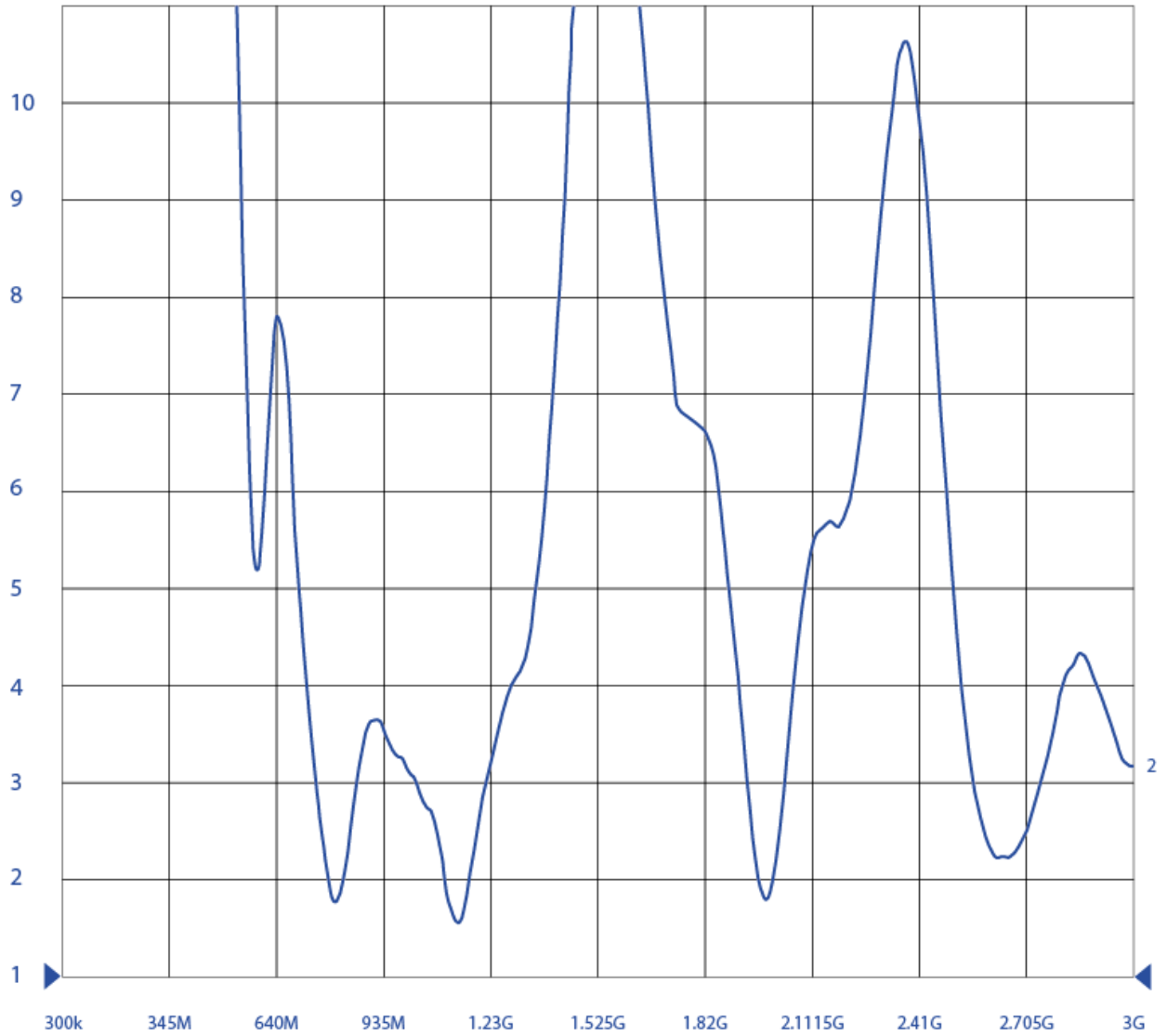

Graph S11 – Return loss [dB]

Tr1 S11 Log Mag 10.00 dB/REF 0.000 dB [RO]
Return Loss

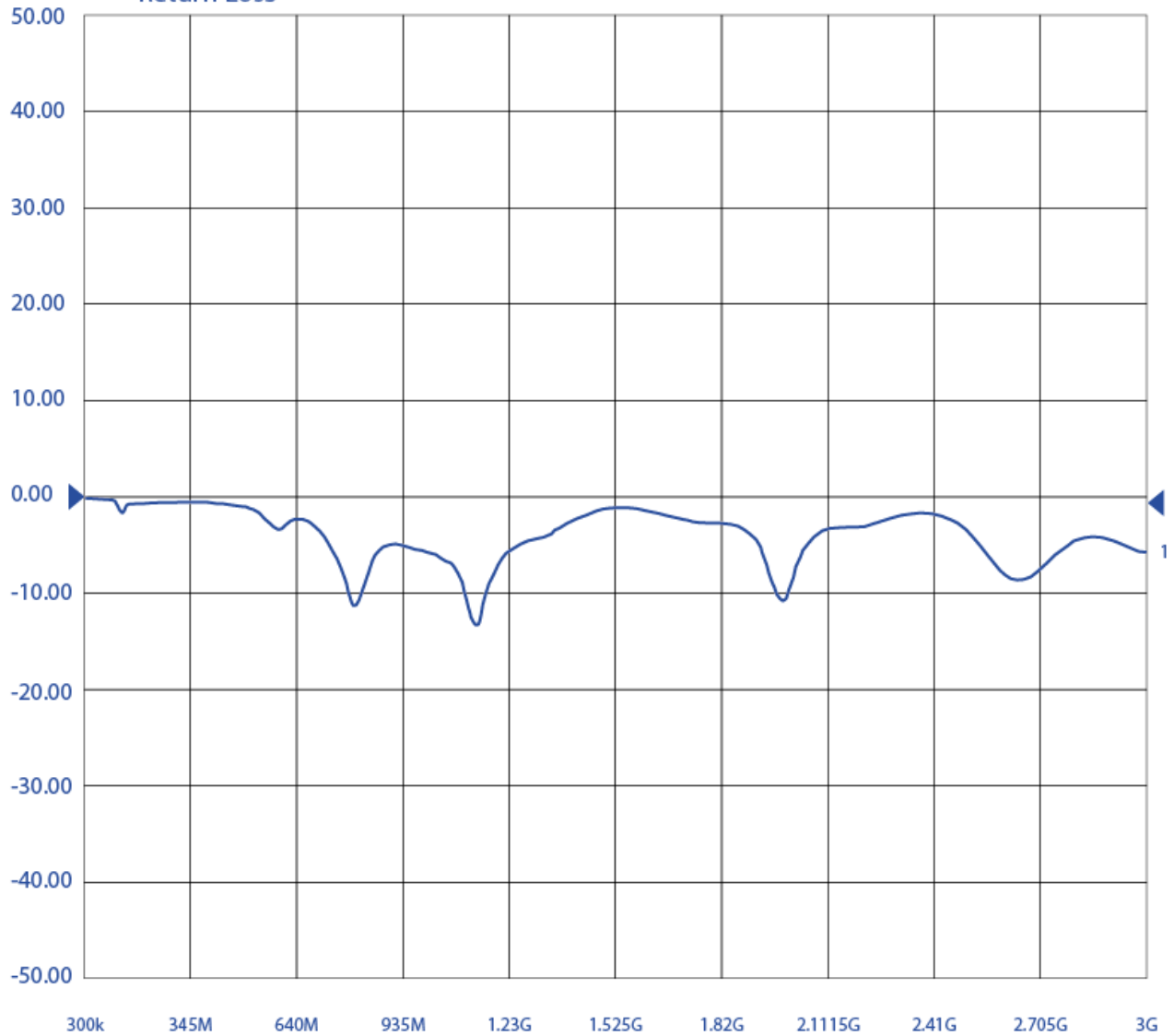

Radiation pattern

800 MHz

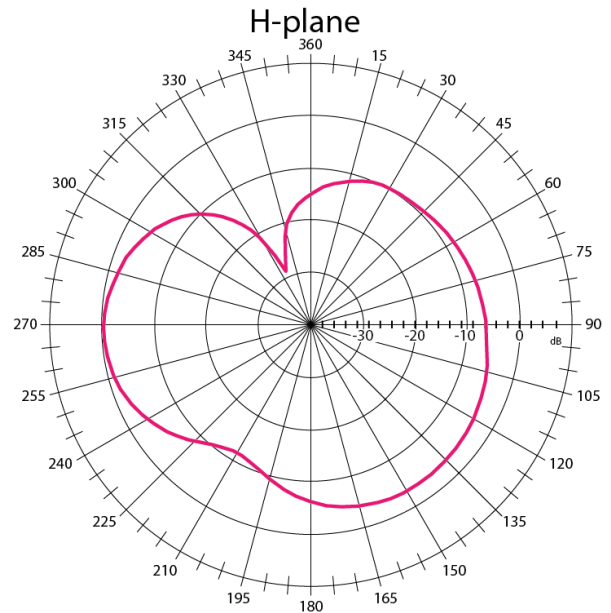
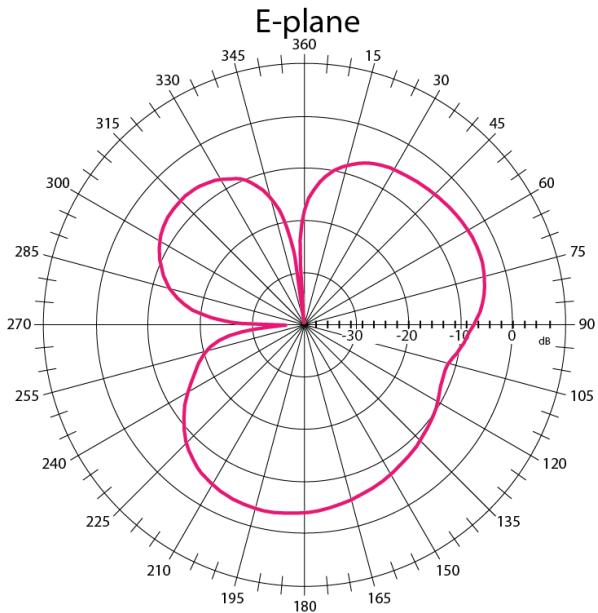

900 MHz

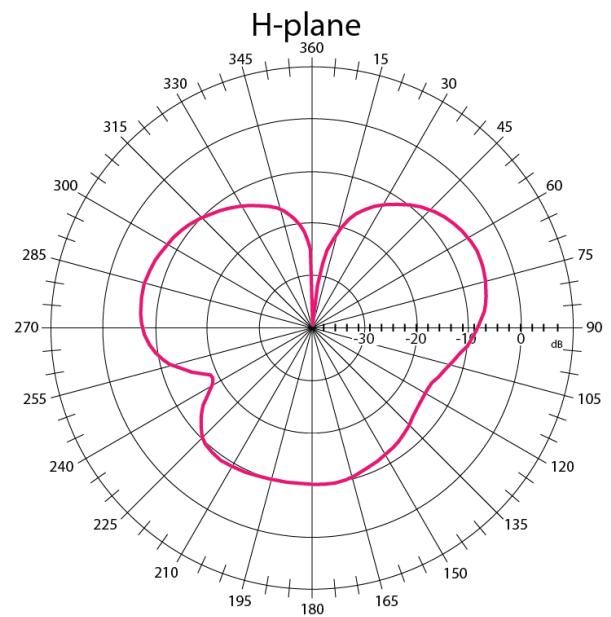
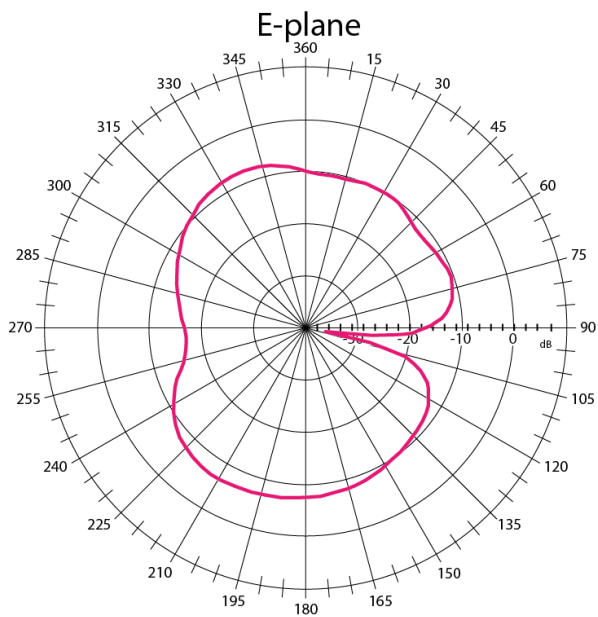

1700 MHz

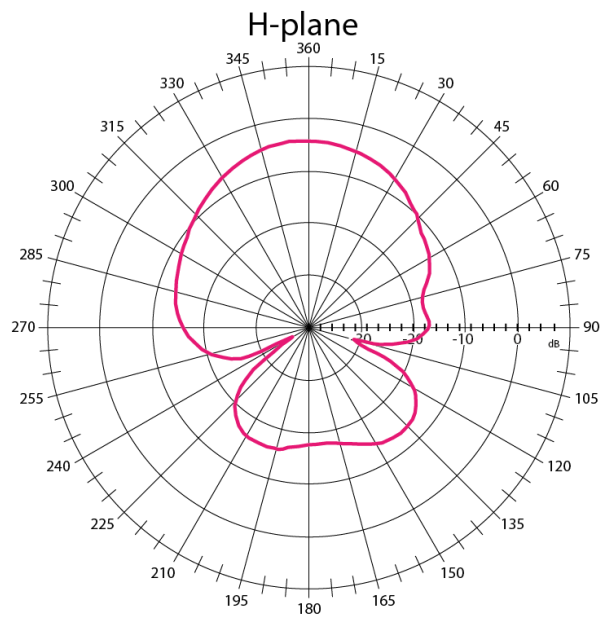
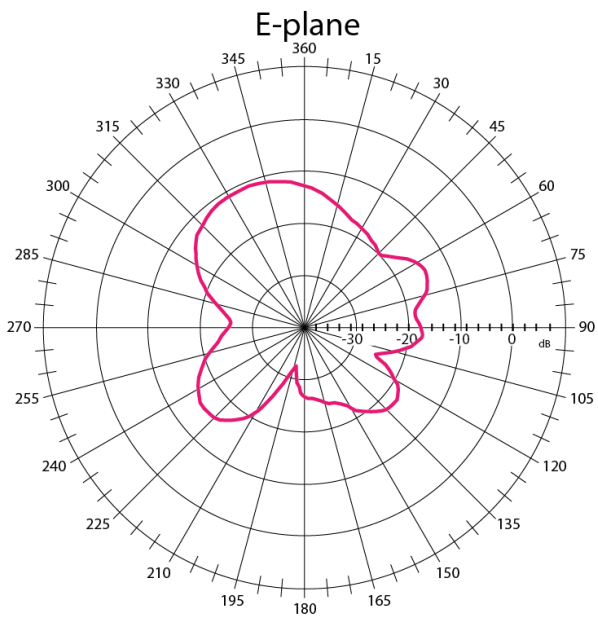

1800 MHz

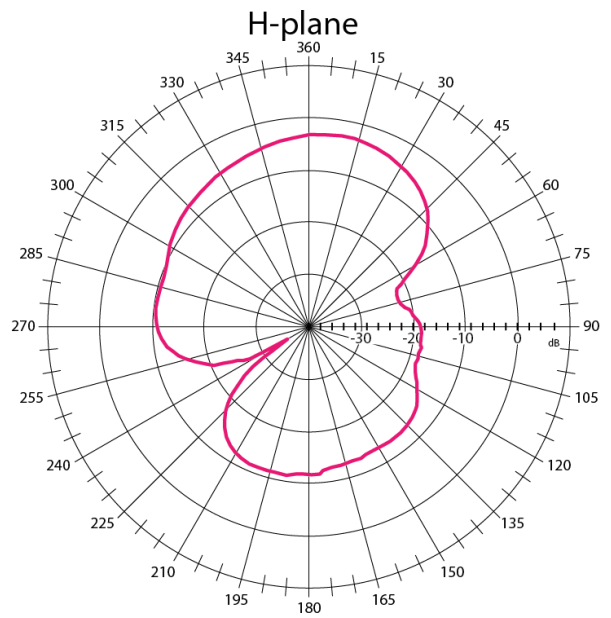
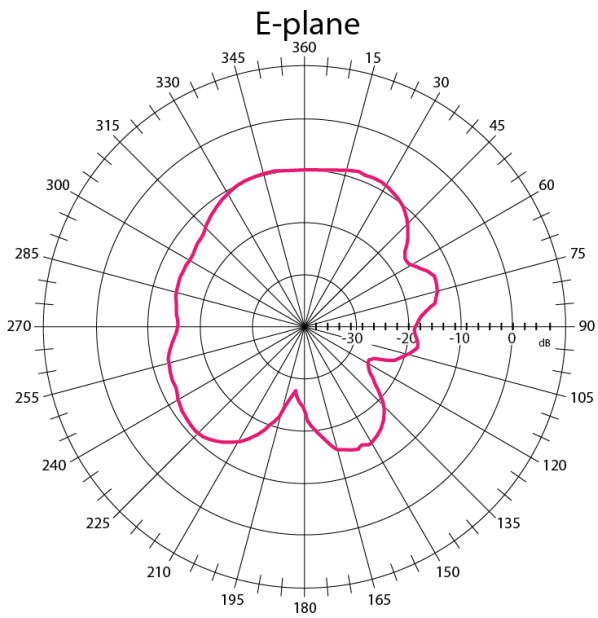

2100 MHz

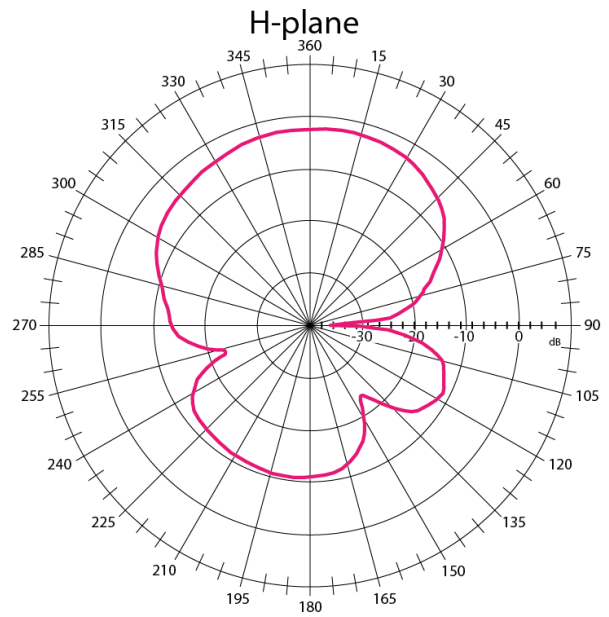
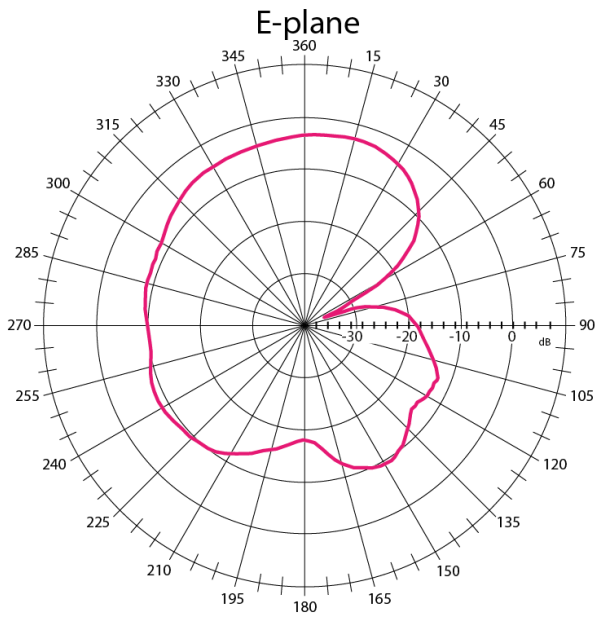

2600 MHz

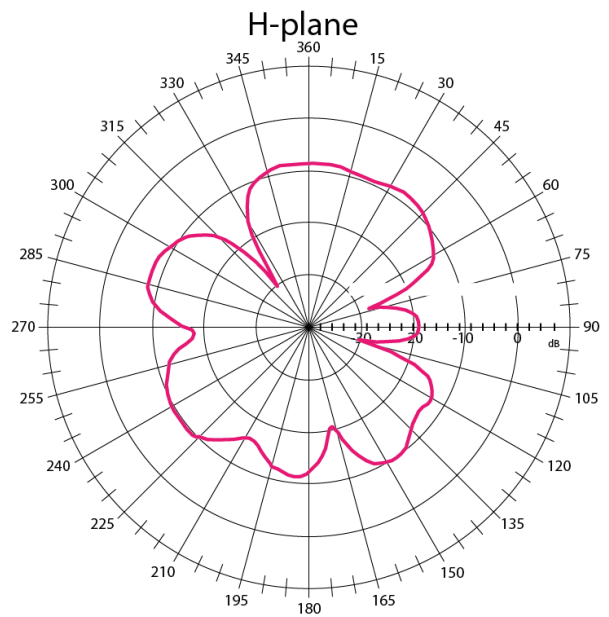
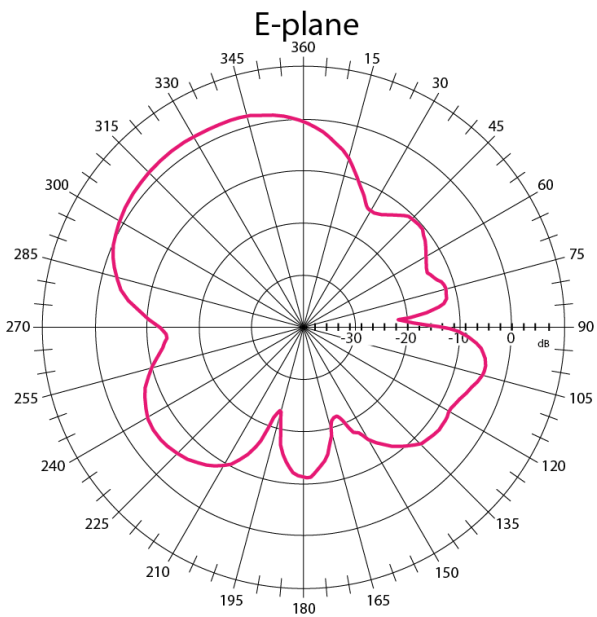

VARIANTS

AO-ALTE-36S020

Different connector variants or cable lengths are available on request.

CONTACTS

SECTRON s.r.o. Josefa Šavla 1271/12
709 00 Ostrava 9, Czech Republic

WWW.SECTRON.CZ
Tel.: +420 556 621 020