



GSM/CDMA/UMTS/LTE /WLAN ANTENNA

Antenna LTE Mounting XL7025,
698–960/1710–2700MHz, 15 dBi,
RG58U/0.1m, SMA(m)

AO-ALTE-XL7025-15-10

SECTRON company offers a wide portfolio of LTE antennas with various versions differing in shape, level of gain and manner of attachment. SECTRON guarantees a compatible connection between an antenna and all antenna adaptors produced by SECTRON.



BENEFITS

- Directional – greater reach
- High gain
- Anti-vandal design
- Anti-corrosive material

Technology	GSM/CDMA/UMTS/LTE/WLAN
Frequency bands	700/800/900/1700/1800/1900/2100/2400/2500/2600/2700 MHz
Bandwidth	262/990 MHz
Gain	15 dBi
VSWR	< 2:1
Impedance	50 Ohm
Directivity	Directional
Beam angle	Attached graphs below
Polarization	Vertical
Maximum input power	10 W
Power voltage	-
Dimensions	445 x 210 x 65 mm
Weight	840 g
Operating temperature	-40 to 60 °C
Execution	External
Method of attachment	Mounting
Cable type	RG58/U
The cable length	0.1 m
Connector type	SMA(m)
Mounting direction	Vertical, Horizontal
Antenna material	Aluminum

DRAWING

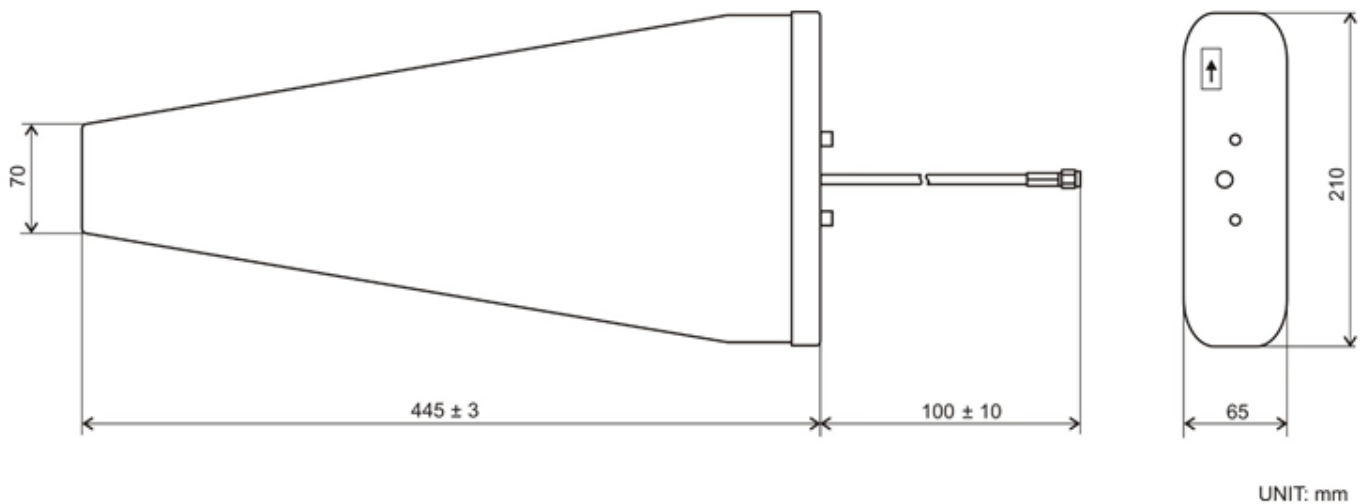

VSWR [-] – Voltage standing wave ratio

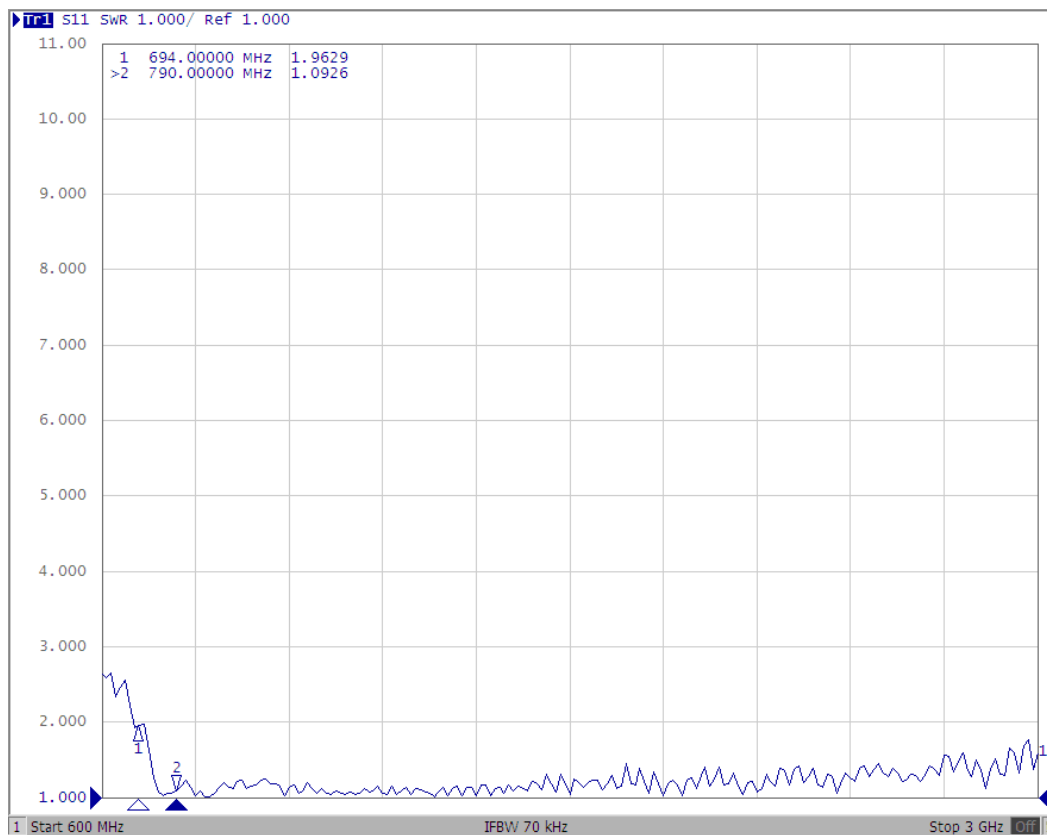

Radiation pattern

700 MHz

824 MHz

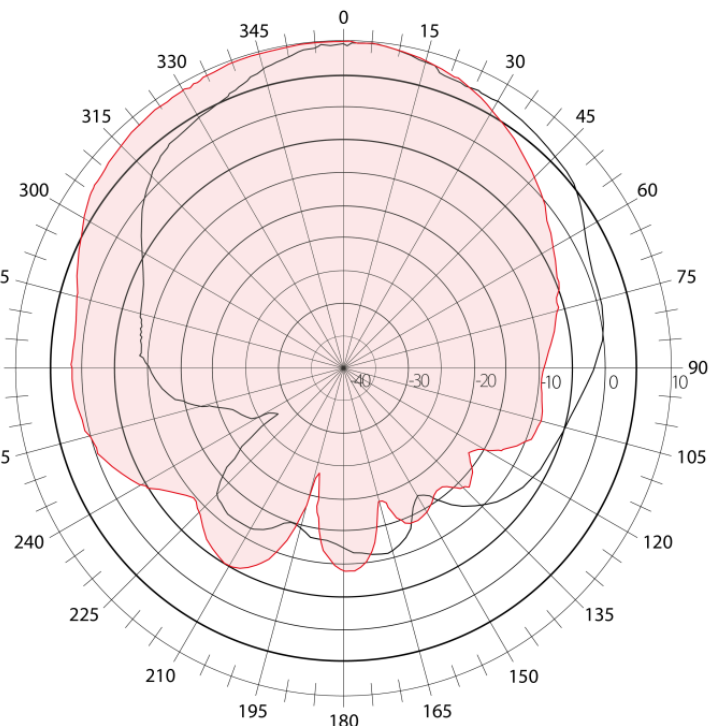
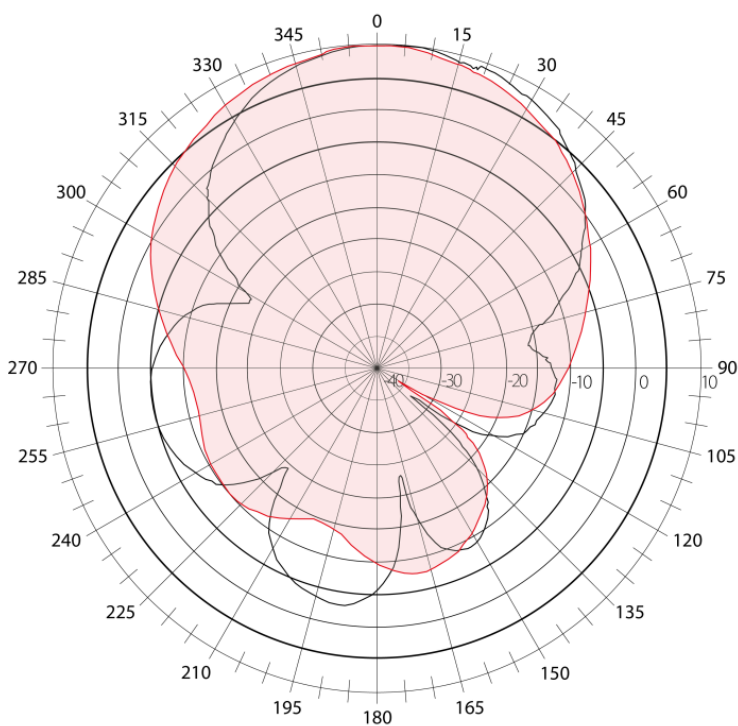

960 MHz

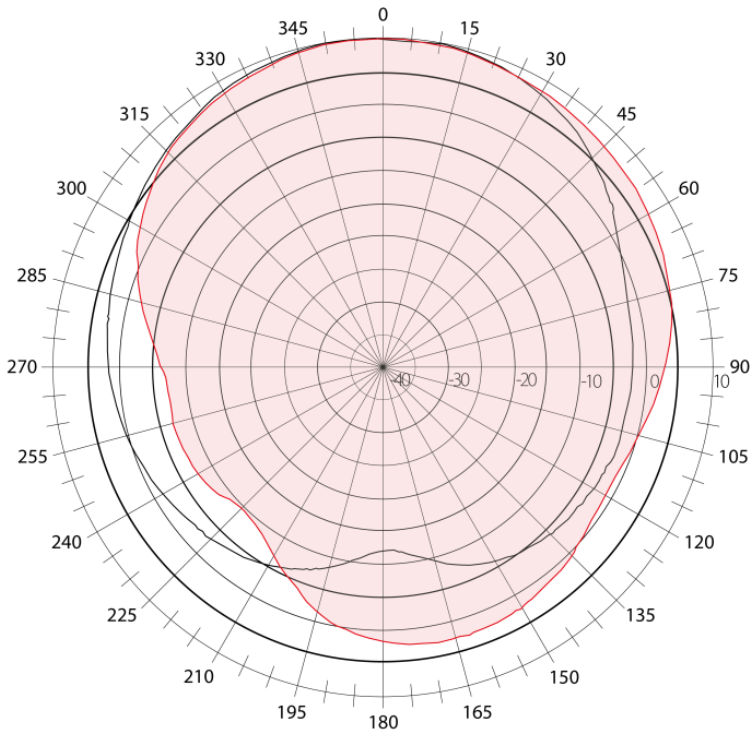

1800 MHz

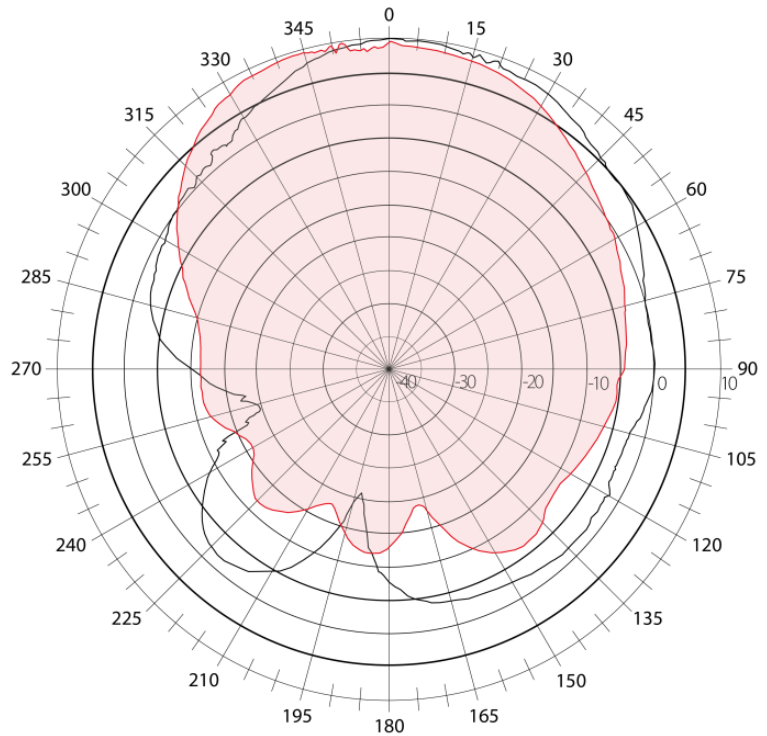

2600 MHz

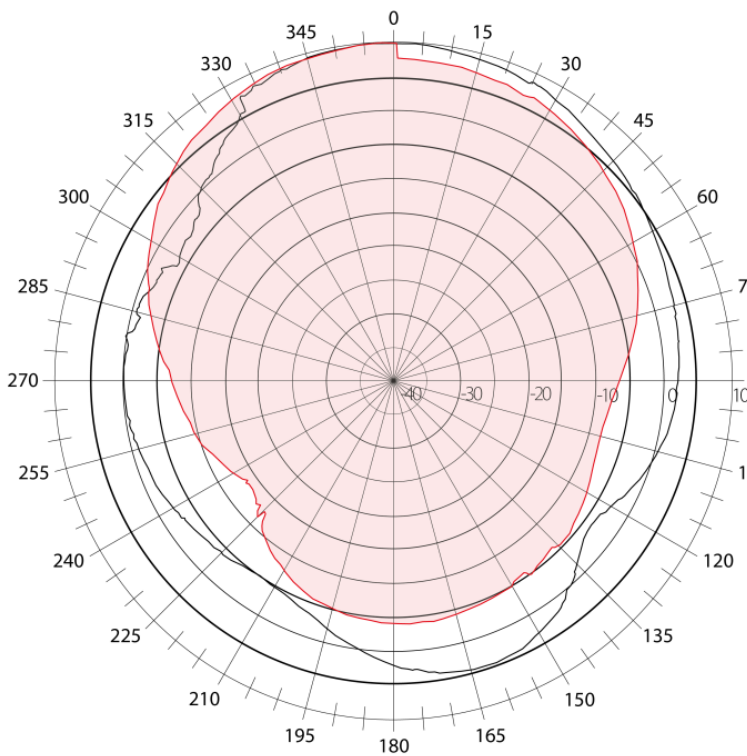

2700 MHz

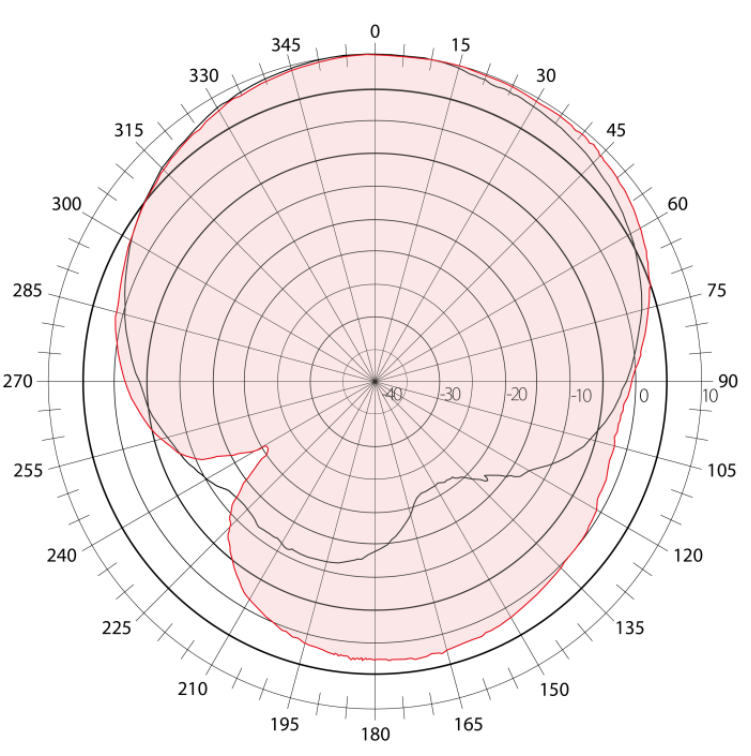

Different connector variants or cable lengths are available on request.

CONTACTS

SECTRON s.r.o. Josefa Šavla 1271/12
709 00 Ostrava 9, Czech Republic

WWW.SECTRON.CZ
Tel.: +420 556 621 021