



GPS ANTENNA

Antenna GPS Adhesive 004,
SMA(m), RG174/5m

AP-AGPS-A004A-S5

SECTRON company offers a wide portfolio of GPS antennas with various versions differing in shape, level of gain and manner of attachment. SECTRON guarantees a compatible connection between an antenna and all antenna adaptors produced by SECTRON.



BENEFITS

- Low VSWR
- Easy installation
- High power supply range

Technology	GPS
Frequency bands	1575.42 MHz
Bandwidth	5 MHz
Gain	28 dBi
VSWR	<1.5:1
Impedance	50 Ohm
Directivity	Omnidirectional
Beam angle	H 360° V 30°
Polarization	R.H.C.P.
Maximum input power	10 W
Power voltage	2.7-10V DC
Dimensions	35.3 x 39.3 x 14.4 mm
Weight	76.15 g
Operating temperature	-40 to +85 °C
Execution	External
Method of attachment	Adhesive
Cable type	RG174/U
The cable length	5 m
Connector type	SMA(m)

DRAWING

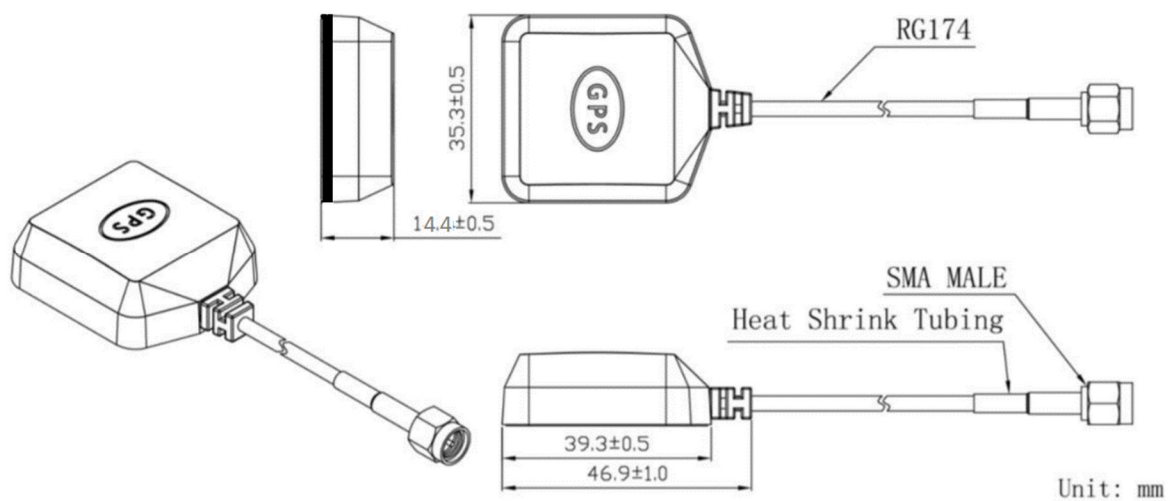

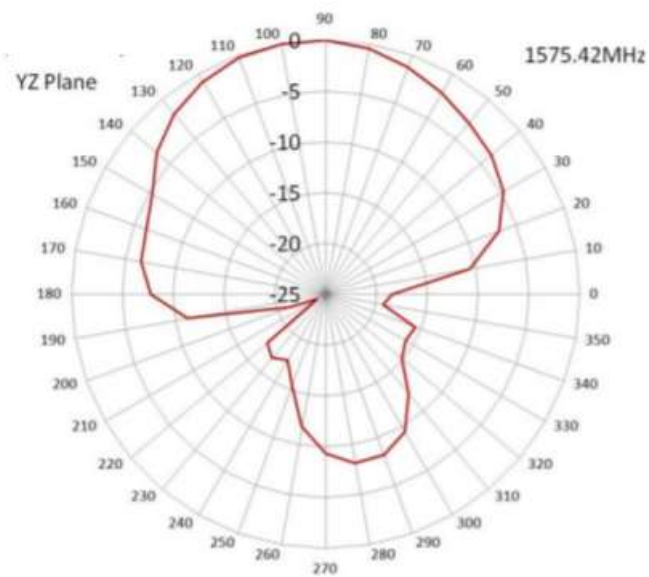
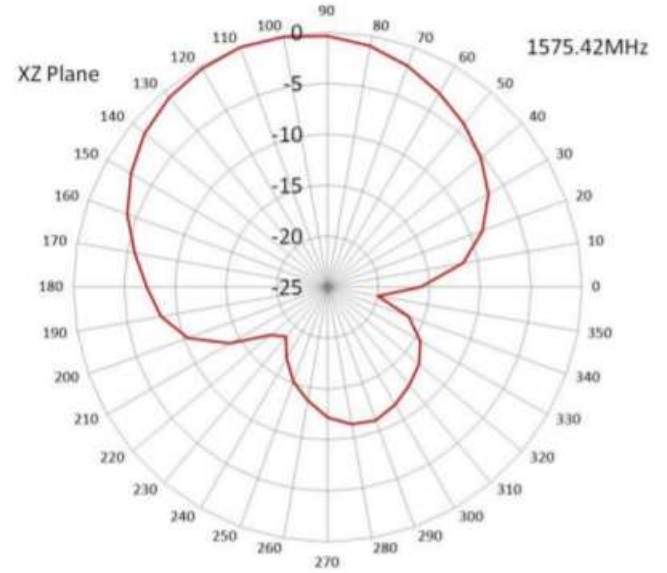
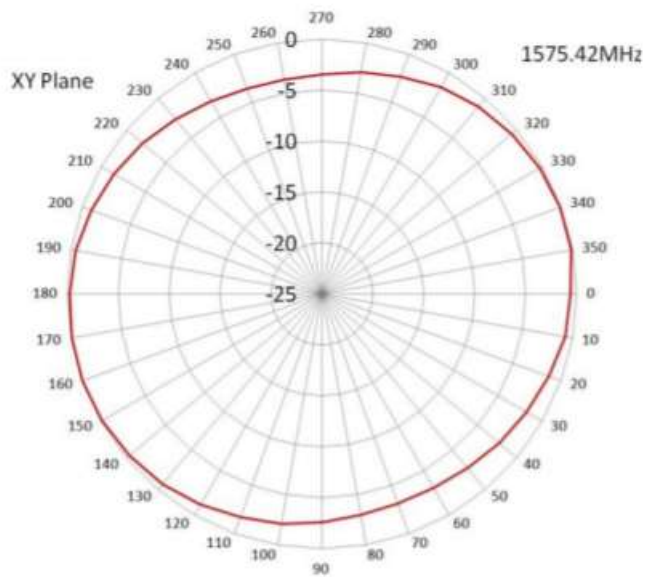

CONTACTS

SECTRON s.r.o. Josefa Šavla 1271/12
709 00 Ostrava 9, Czech Republic

WWW.SECTRON.CZ
Tel.: +420 556 621 021