



## WiFi ANTENNA

Antenna WiFi Adhesive W001,  
2.4 GHz, MCX(m) cable  
straight, RG174/3m, IP65/IP66

AW-A24G-W001AC

SECTRON company offers a wide portfolio of WiFi antennas with various versions differing in shape, level of gain and manner of attachment. SECTRON guarantees a compatible connection between an antenna and all antenna adaptors produced by SECTRON.



### BENEFITS

- Low VSWR
- Easy installation

Technology	WiFi
Frequency bands	2400 MHz
Bandwidth	-
Gain	2 dBi
VSWR	<1.5:1
Impedance	50 Ohm
Directivity	Omnidirectional
Beam angle	H 360° V 30°
Polarization	R.H.C.P
Maximum input power	10 W
Power voltage	-
Dimensions	39.3 x 49.4 x 14.9 mm
Weight	64.56 g
Operating temperature	-40 to +85 °C
Execution	External
Method of attachment	Adhesive
Cable type	RG174/U
The cable length	3 m
Connector type	MCX(m)
IP CODE	IP65/IP66

DRAWING

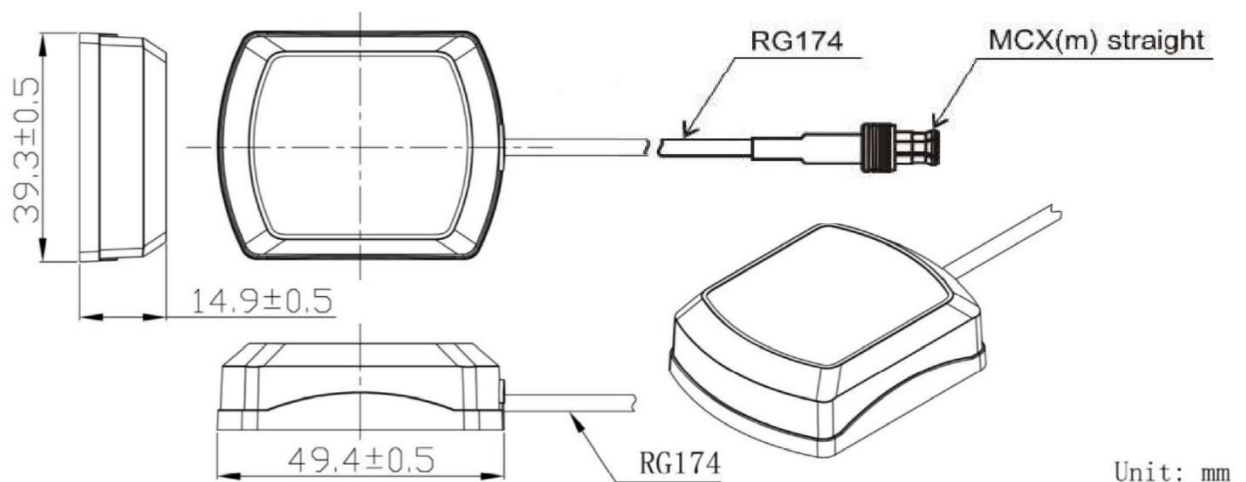

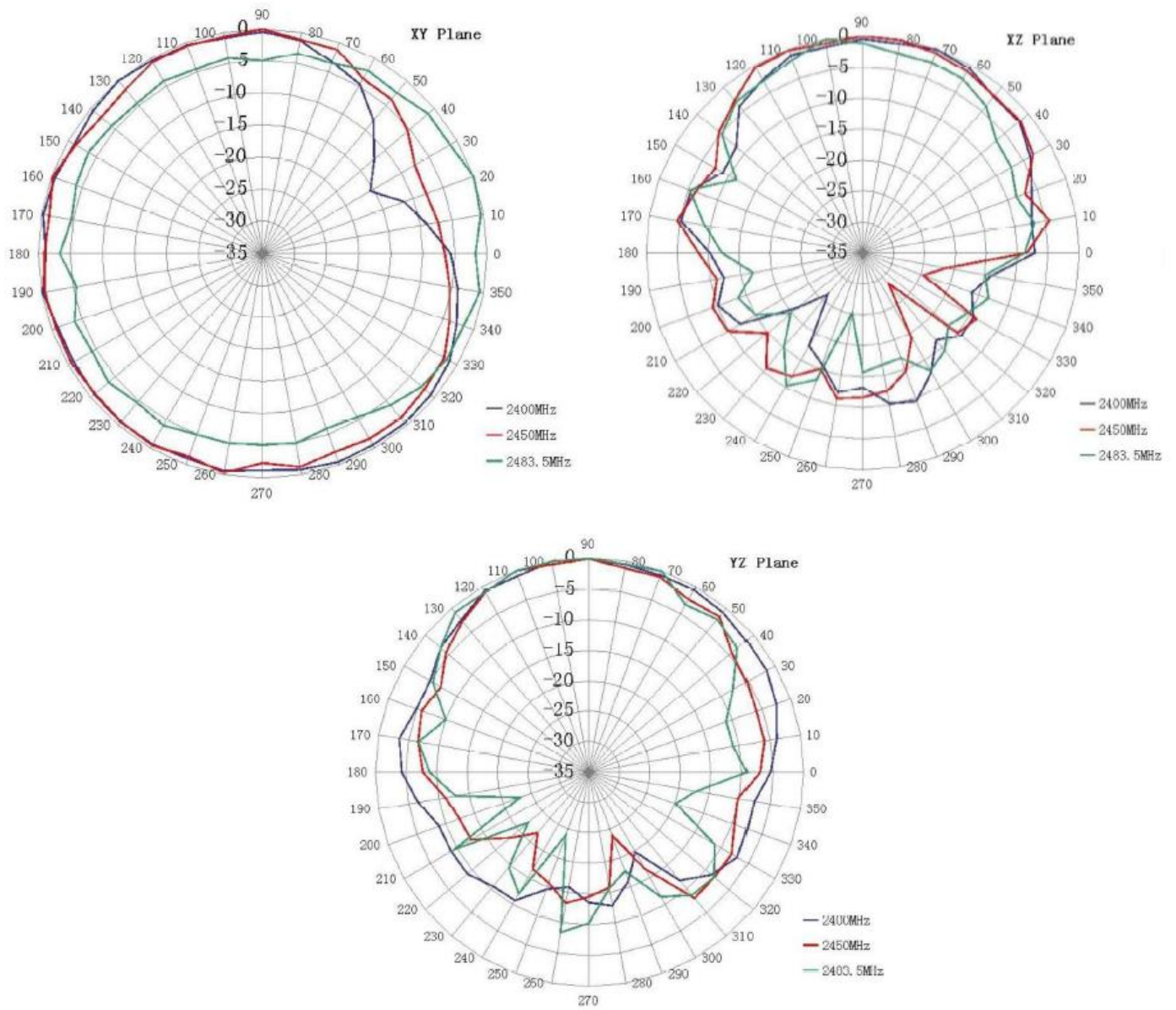

## CONTACTS

SECTRON s.r.o. Josefa Šavla 1271/12  
709 00 Ostrava 9, Czech Republic

WWW.SECTRON.CZ  
Tel.: +420 556 621 021